

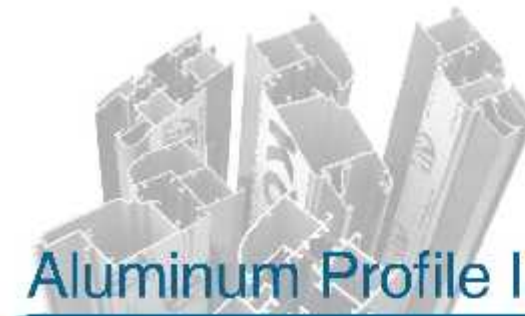

Mould Design & Manufacturing



تولید کننده انواع پروفیل های آلومینیوم اختصاصی، صنعتی و ساختمانی

Aluminum Profile Industrial co.

Aluminum Bilet

واحد طراحی و ساخت قالب

شامل دو بخش طراحی و ساخت قالب می باشد که پس از دریافت طرح اولیه و مشاوره با مهندسین و متخصصین امر ساخته شده و جهت تست اولیه قالب در اختیار واحد اکسترودر قرار می گیرد. قالب های شرکت کوتر پروفیل قابلیت تولید پروفیل تا ظرفیت ۲۰ تن یا قیلر اولیه (حداقل یک مبلیمتر) را دارا می باشد.

واحد مصرفی

بلیت های مصرفی در خط تولید شرکت از بهترین و مرغوب ترین مواد داخلی و خارجی می باشد که تمام اسناد رهای لازمه را برای تولید محصولی با کیفیت را دارا است.



Door & window Systems



در و پنجره آلومینیومی

پنجره آلومینیومی معمولی علی‌رغم استحکام مناسب آن دارای خاصیت هادی بودن می‌باشد که این مسئله باعث تبادل حرارتی بالا ما بین فضای داخلی و بیرونی می‌گردد که هدر رفتن انرژی به میزان زیادی را به همراه خواهد داشت. برای رفع این مشکل پنجره آلومینیومی جدیدی به نام ترمال بریک در دنیا عرضه شده است، که با حفظ استحکام بالای آلومینیوم با افزودن لایه عایق میانی پلی‌امید باعث پدیده شکست حرارتی می‌گردد که وزه ترمال بریک نیز ریشه در همین امر دارد.

این پنجره‌ها از دو لایه داخلی و بیرونی تشکیل شده‌اند که با یک عایق پلی‌امید از یکدیگر جدا شده و عایق حرارتی می‌گردد. امتیاز دیگر برای پروفیل ترمال بریک، این است که باعث کاهش پدیده شبنم روی سطح پنجره می‌شود. هوای مرطوب خیلی زود سرد می‌شود و بخار متجمد شده به صورت قطرات کوچک روی سطح سرد پروفیل ظاهر می‌گردد. هر قدر سعی کنیم که سطح داخلی پروفیل را گرم‌تر نگه داریم این پدیده بیشتر کاهش پیدا می‌کند. امتیازات ویژه ذکر شده همراه با زیبایی منحصر به فرد این محصول به گونه ایست که در بیشتر ساختمان‌های مدرن امروزی سیستم پنجره‌های ترمال بریک کاربرد گسترده یافته‌اند.

EW 69

Door & window System



Door & window System

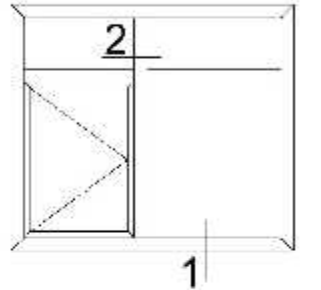
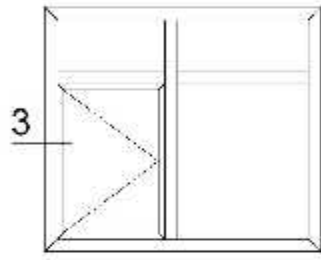

Detail 3

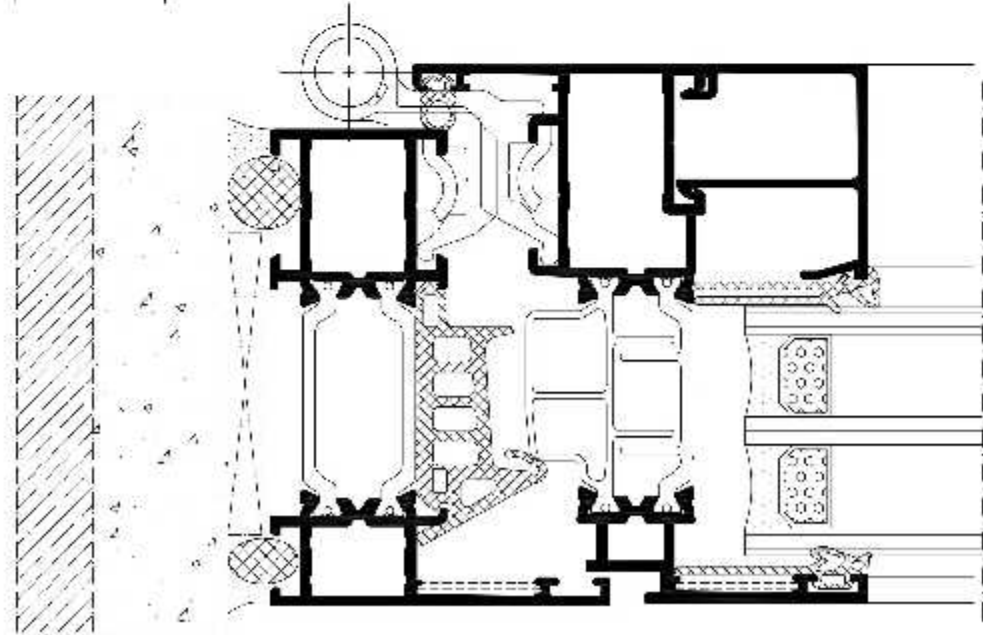

Detail 1

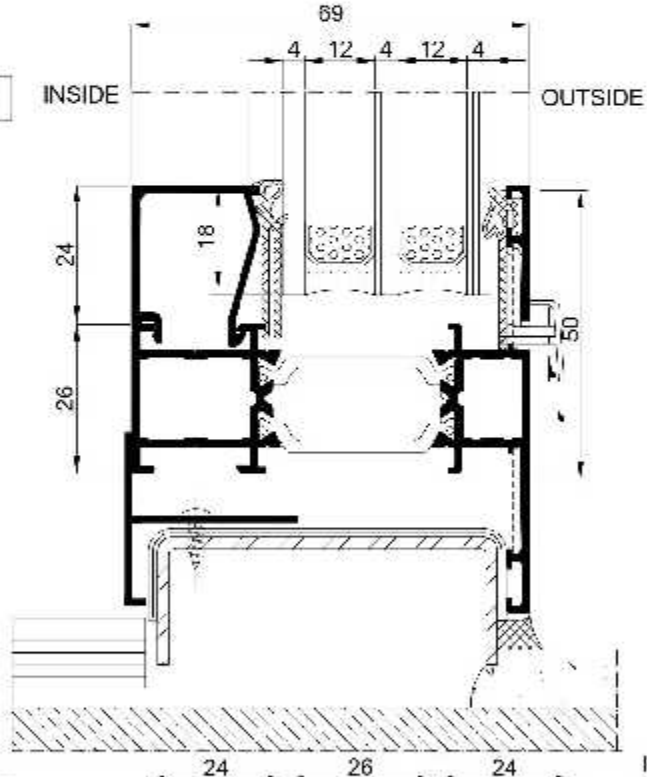

Detail 2

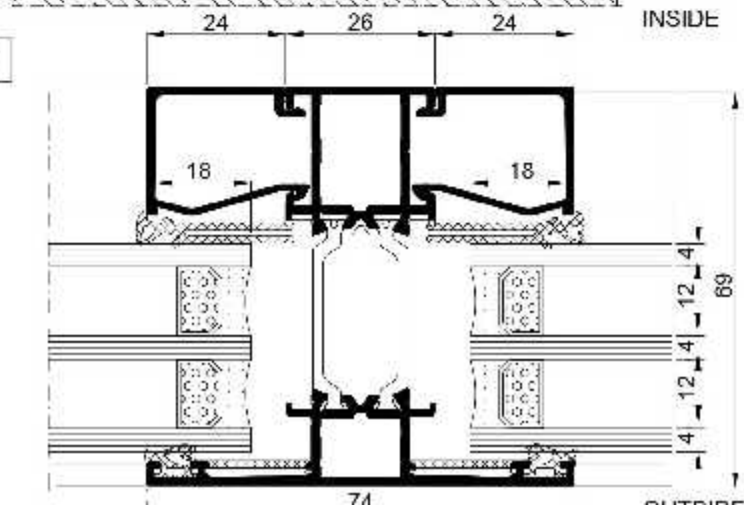

EW 69

Door & window
System

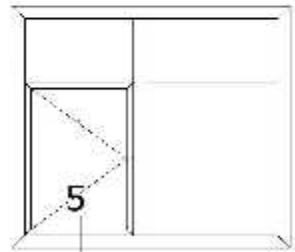

Detail 5

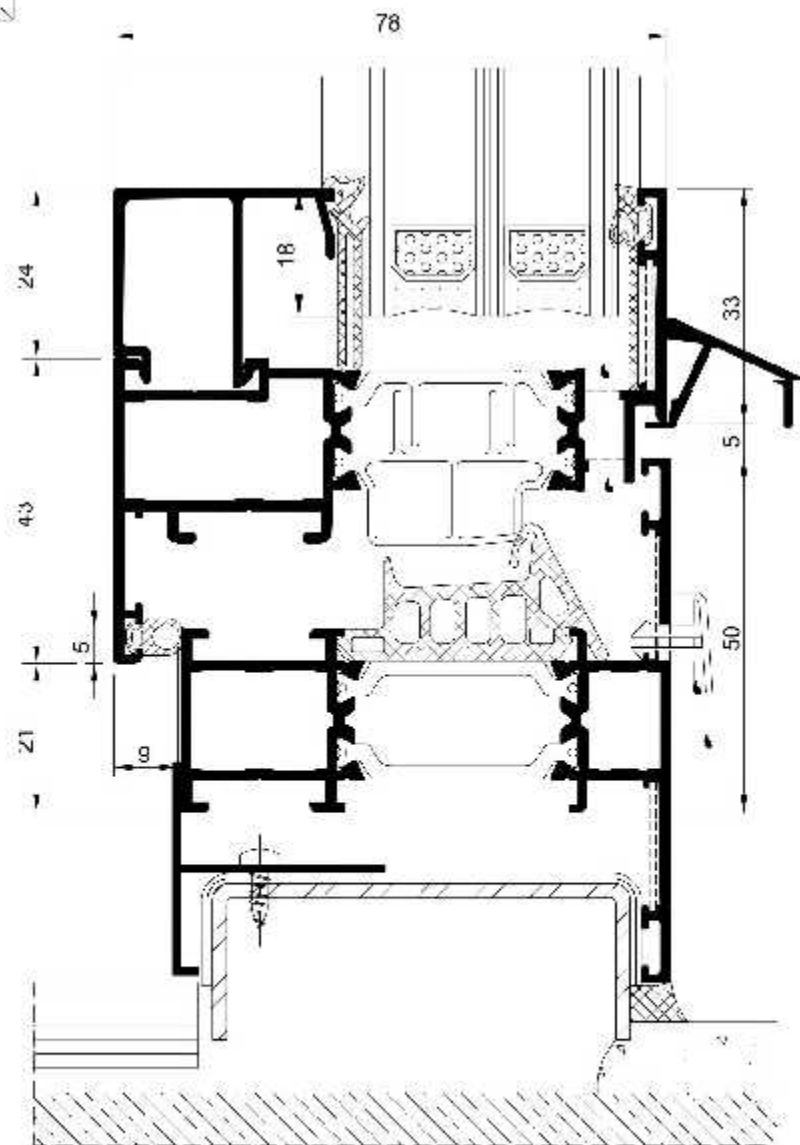

Door & window
System

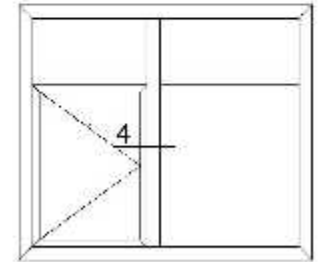

Detail 4

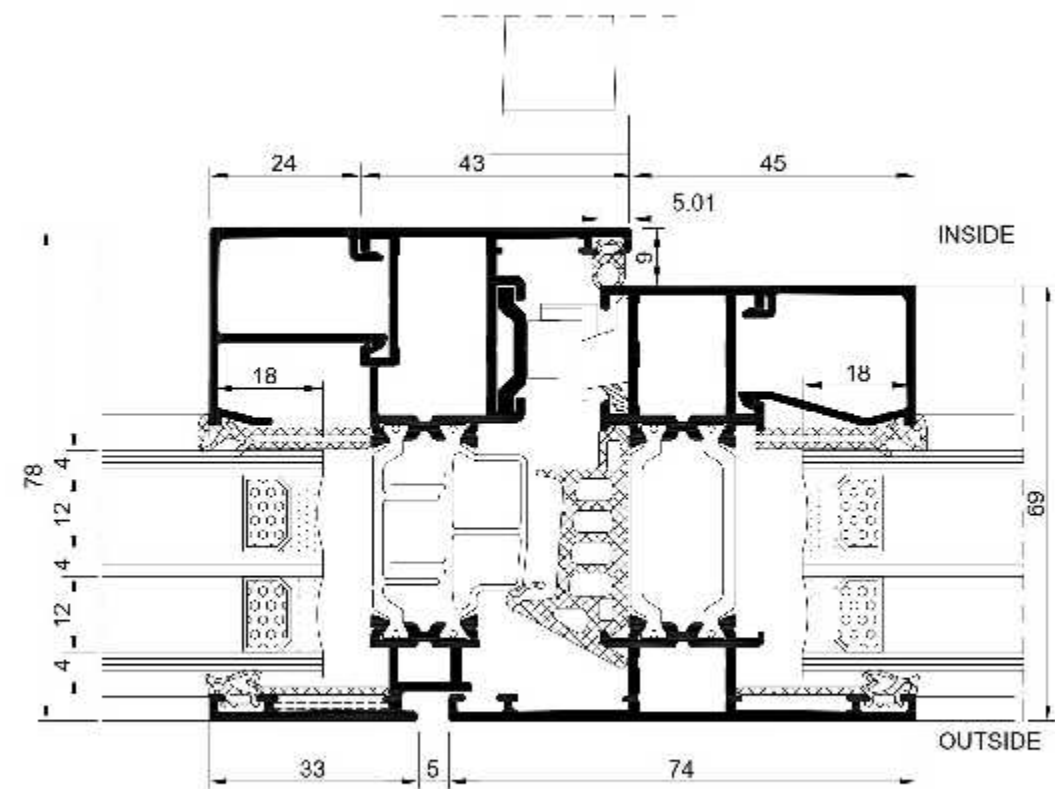

EW 69

Door & window Hidden System



Door & window Hidden System

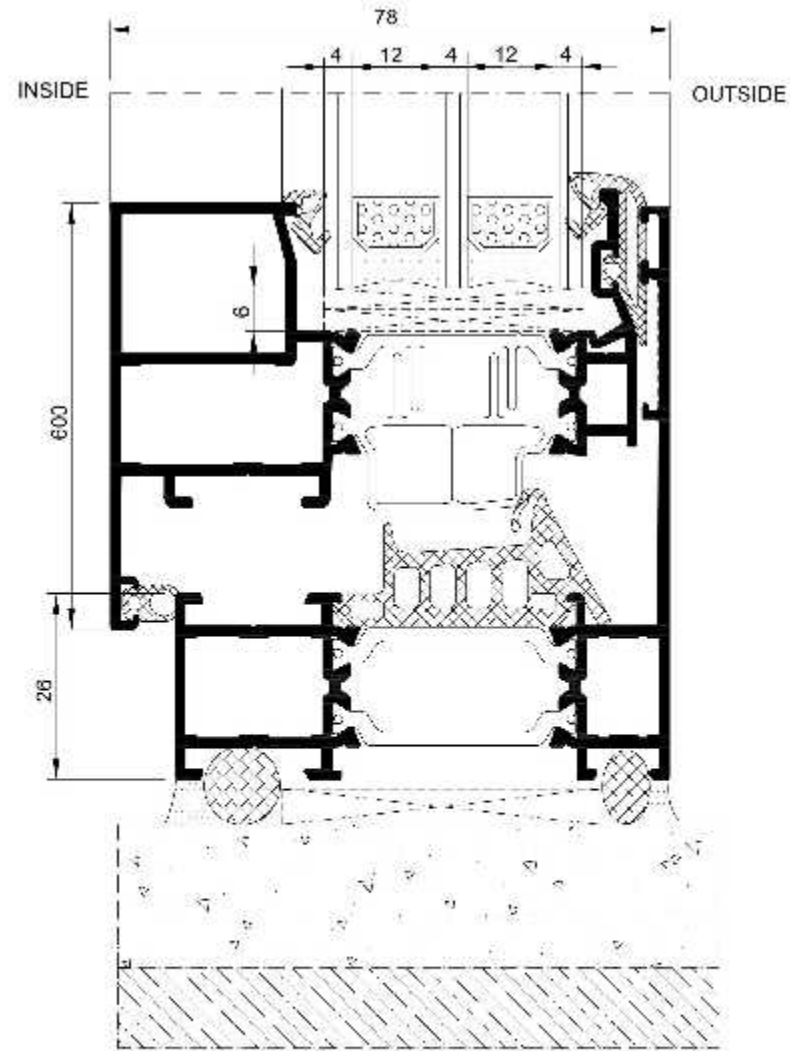
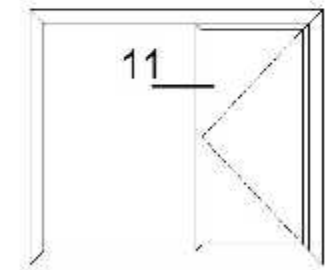
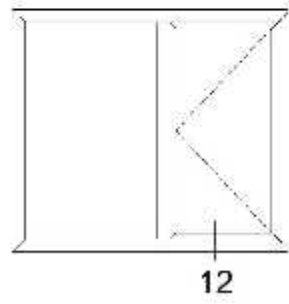

Detail 11

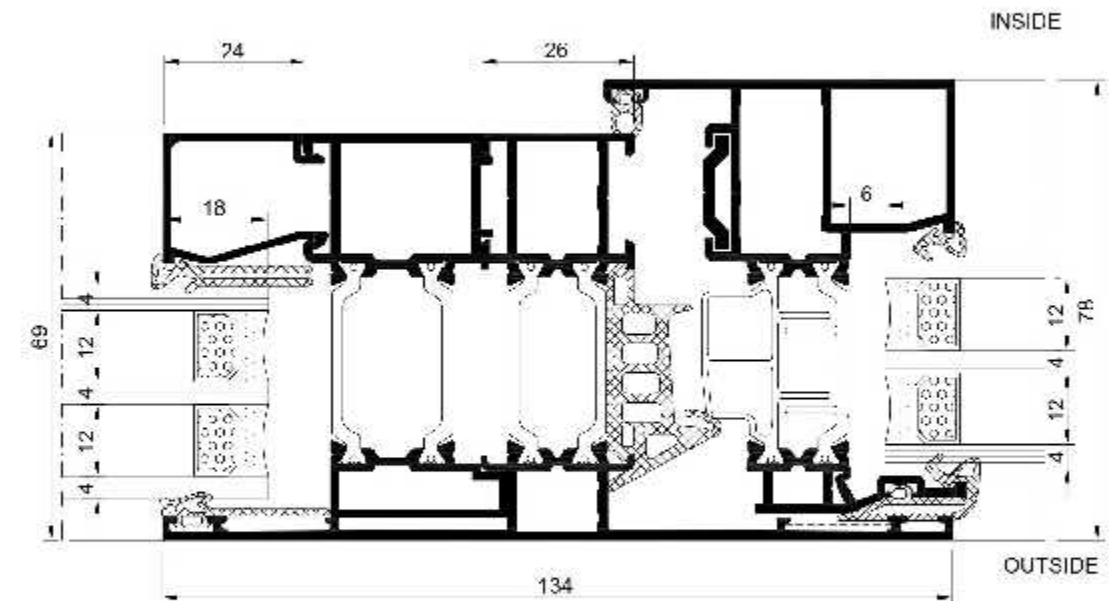

EW 69

Door & window Tilt & Slide System



Door & window Tilt & Slide System

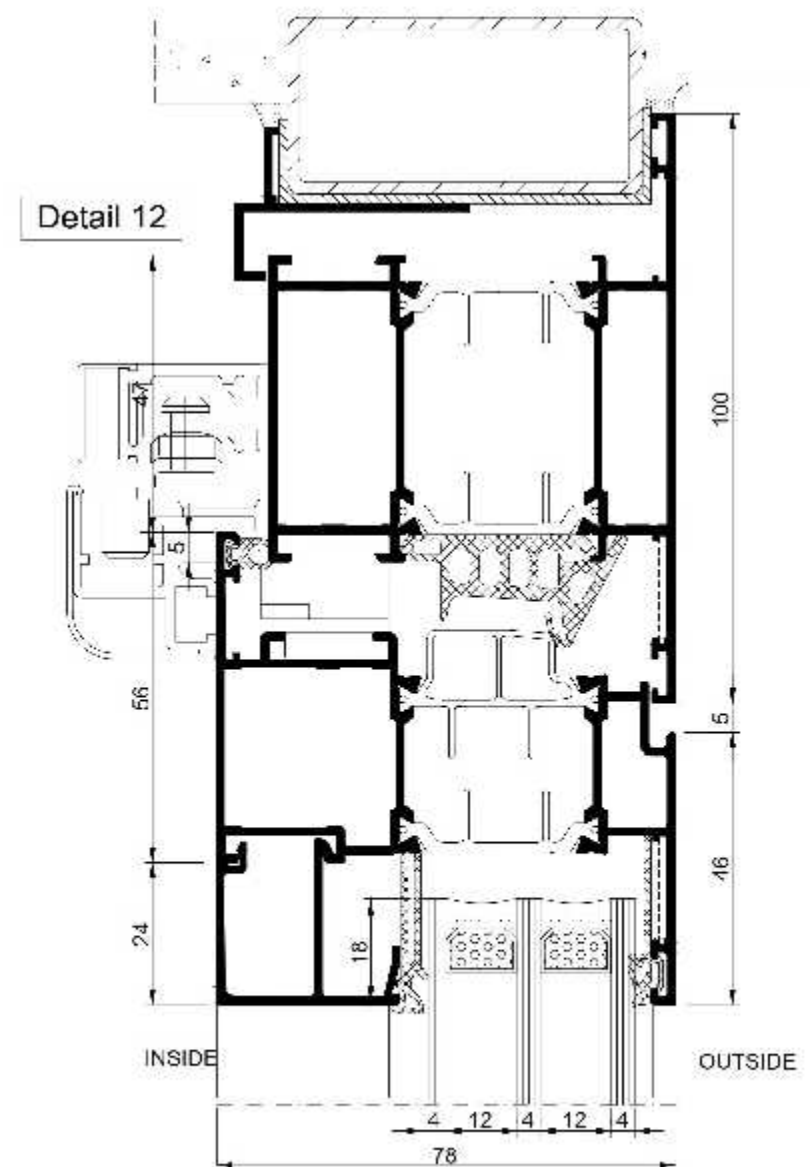
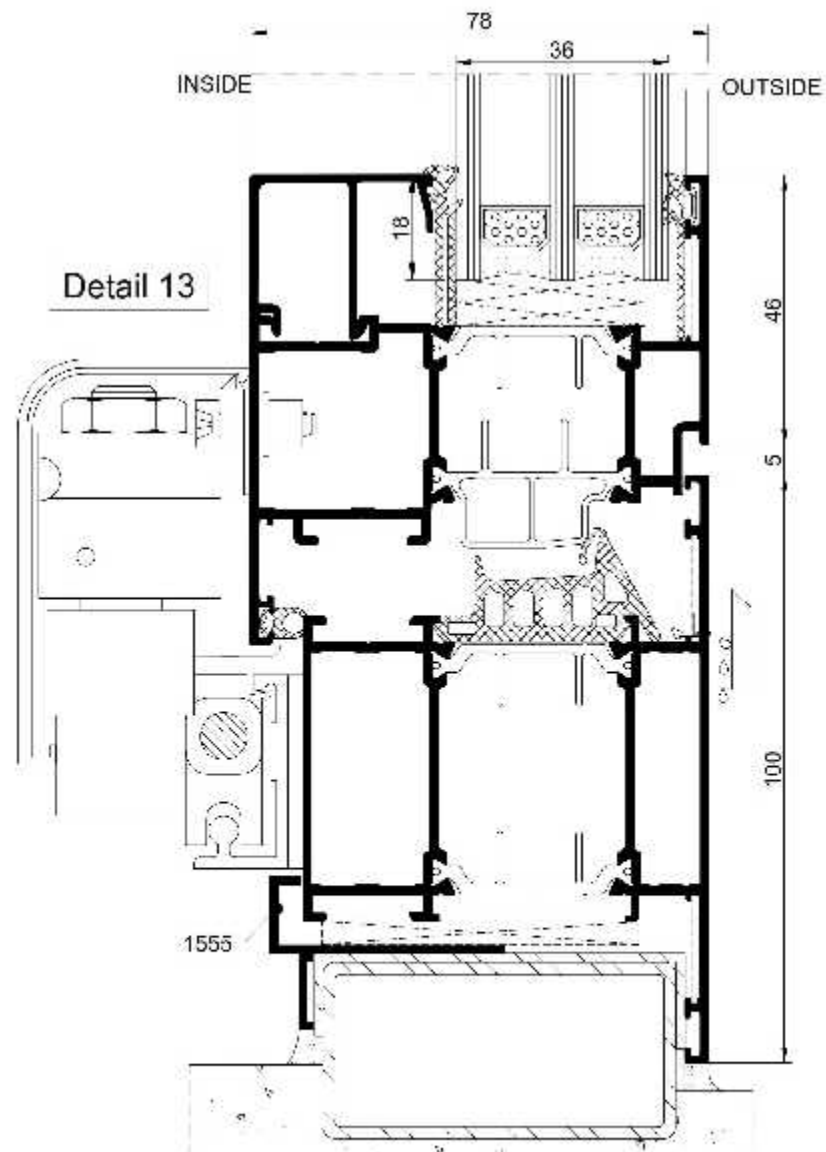
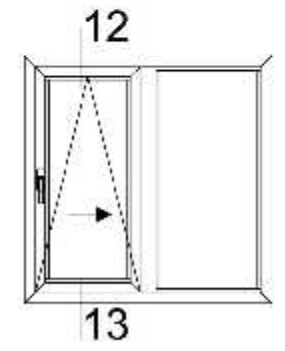
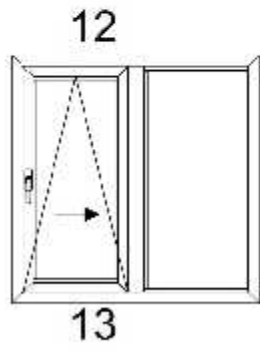

EW 69

Door & window Folding System



Door & window Folding System

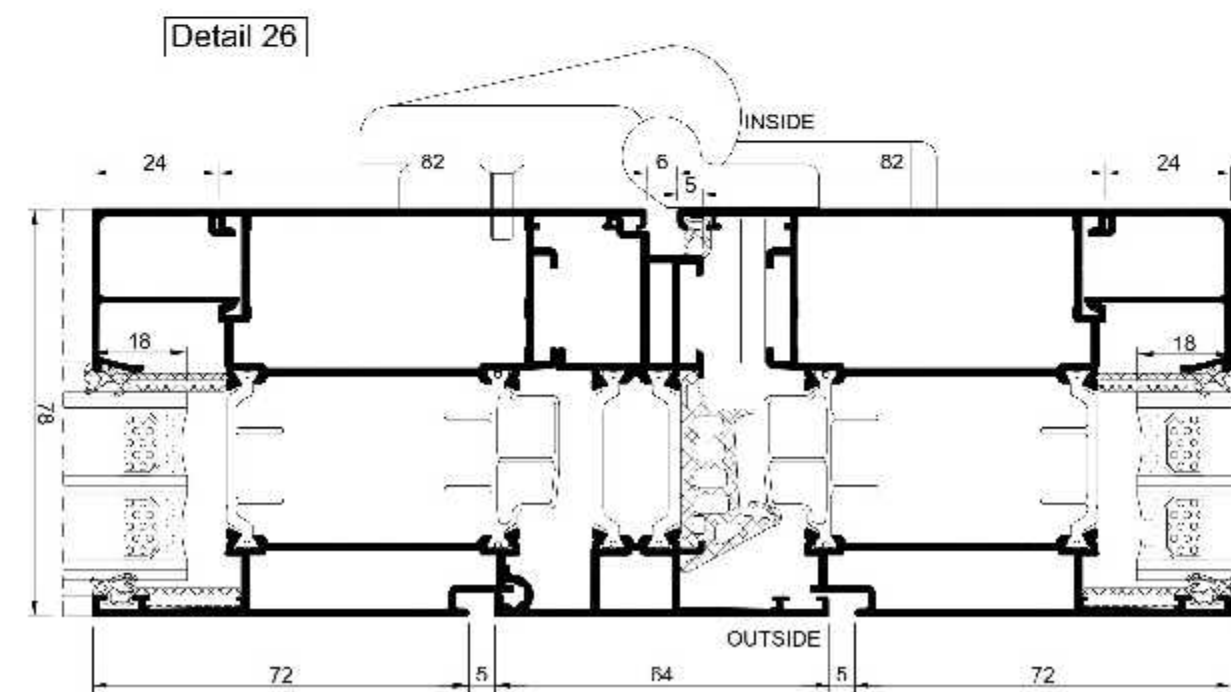
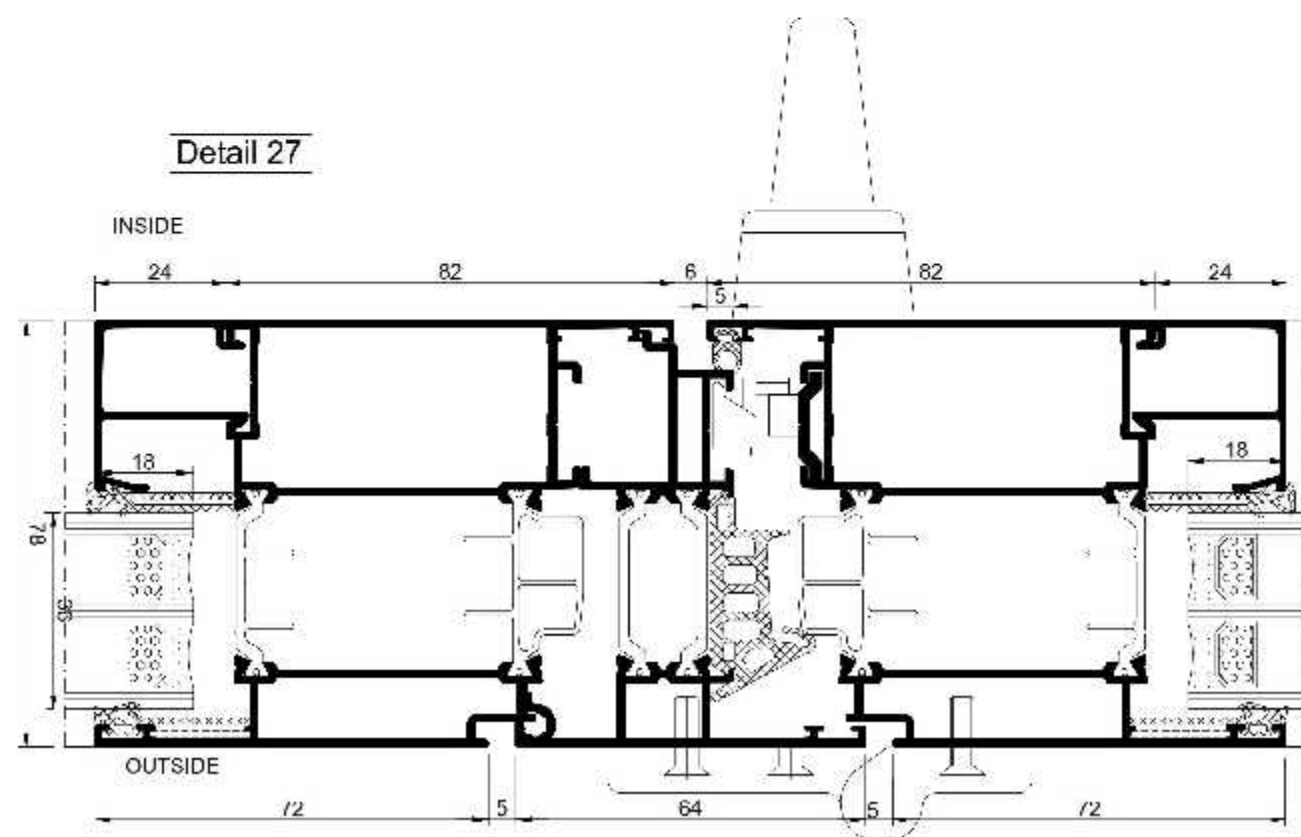
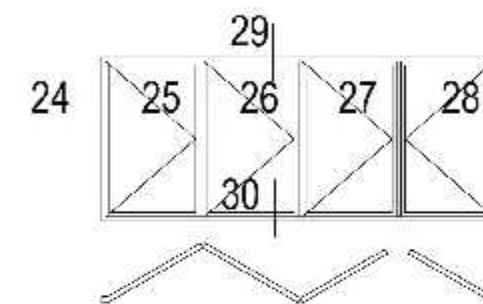
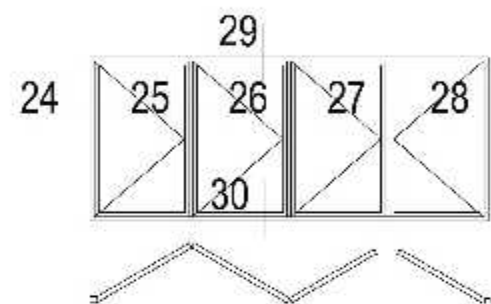

EW 69



Door & window Folding System

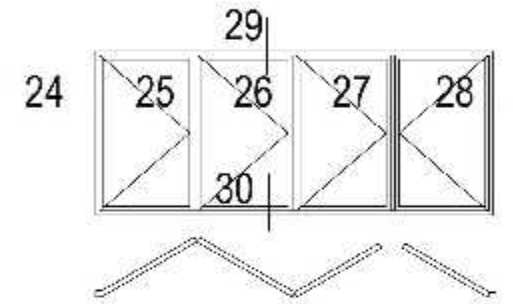

Detail 30

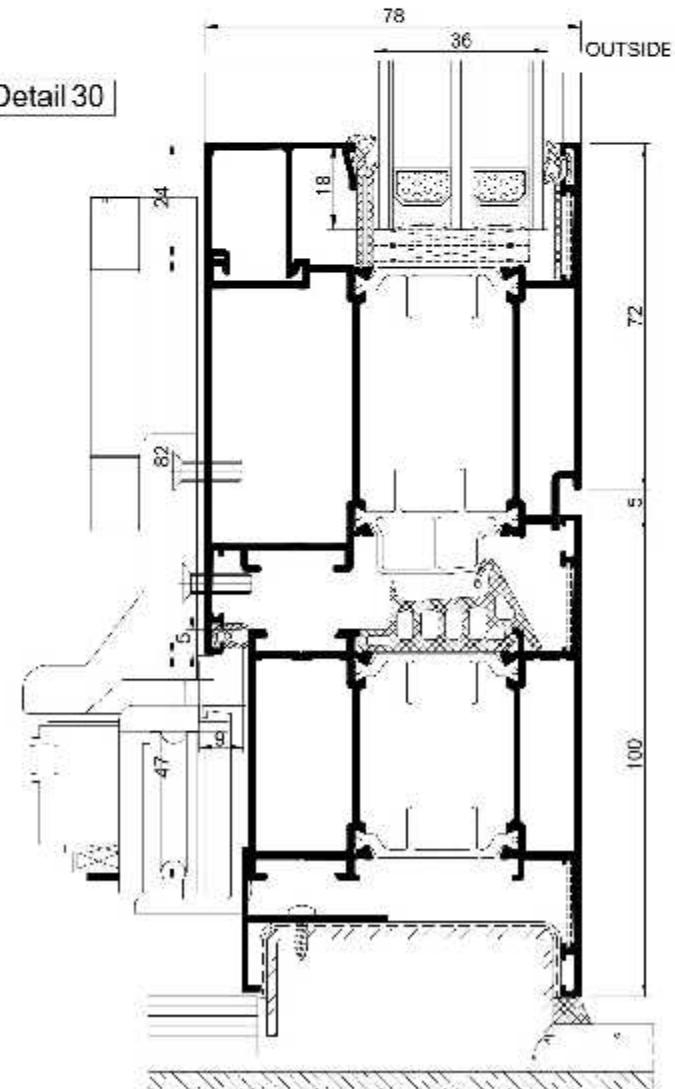

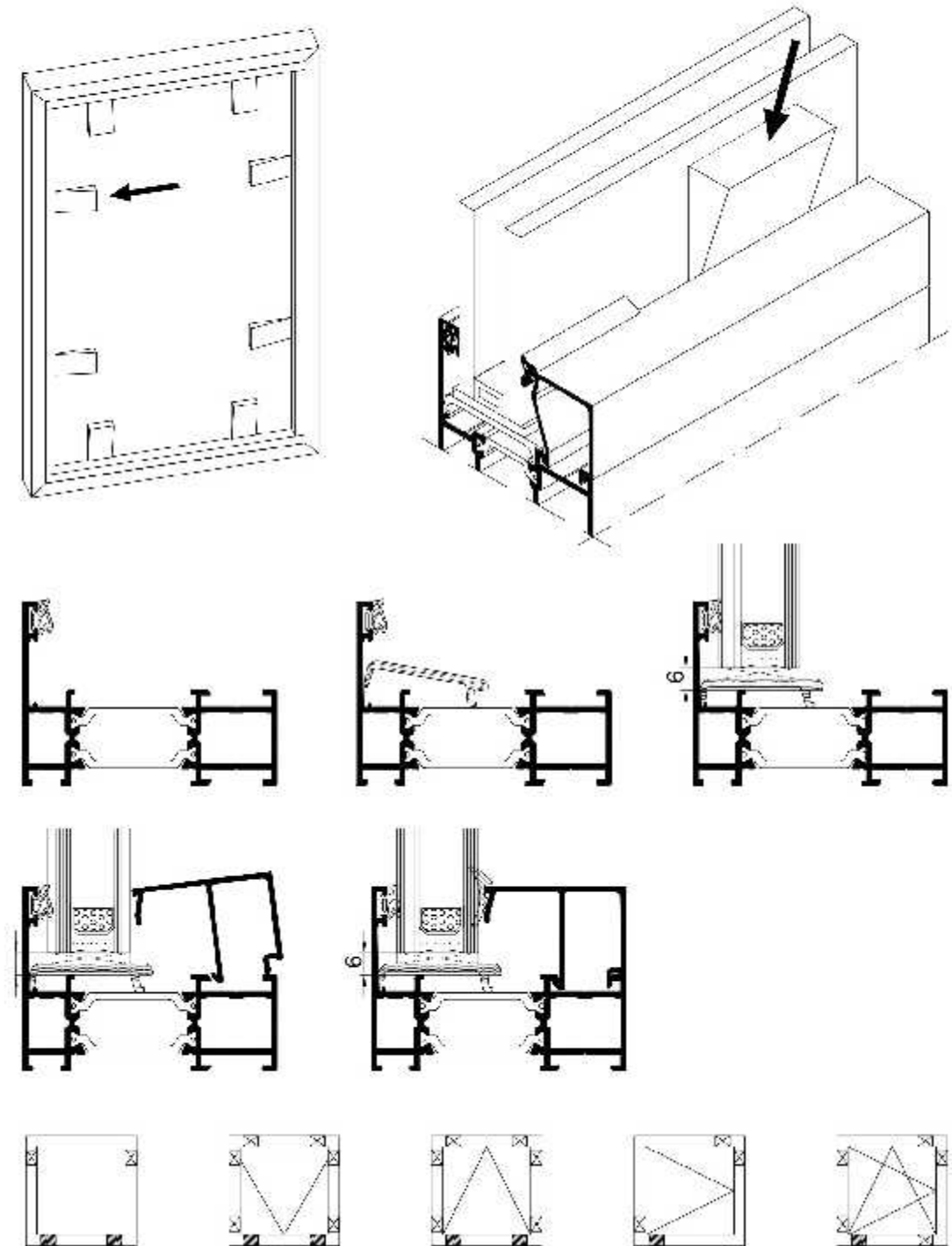
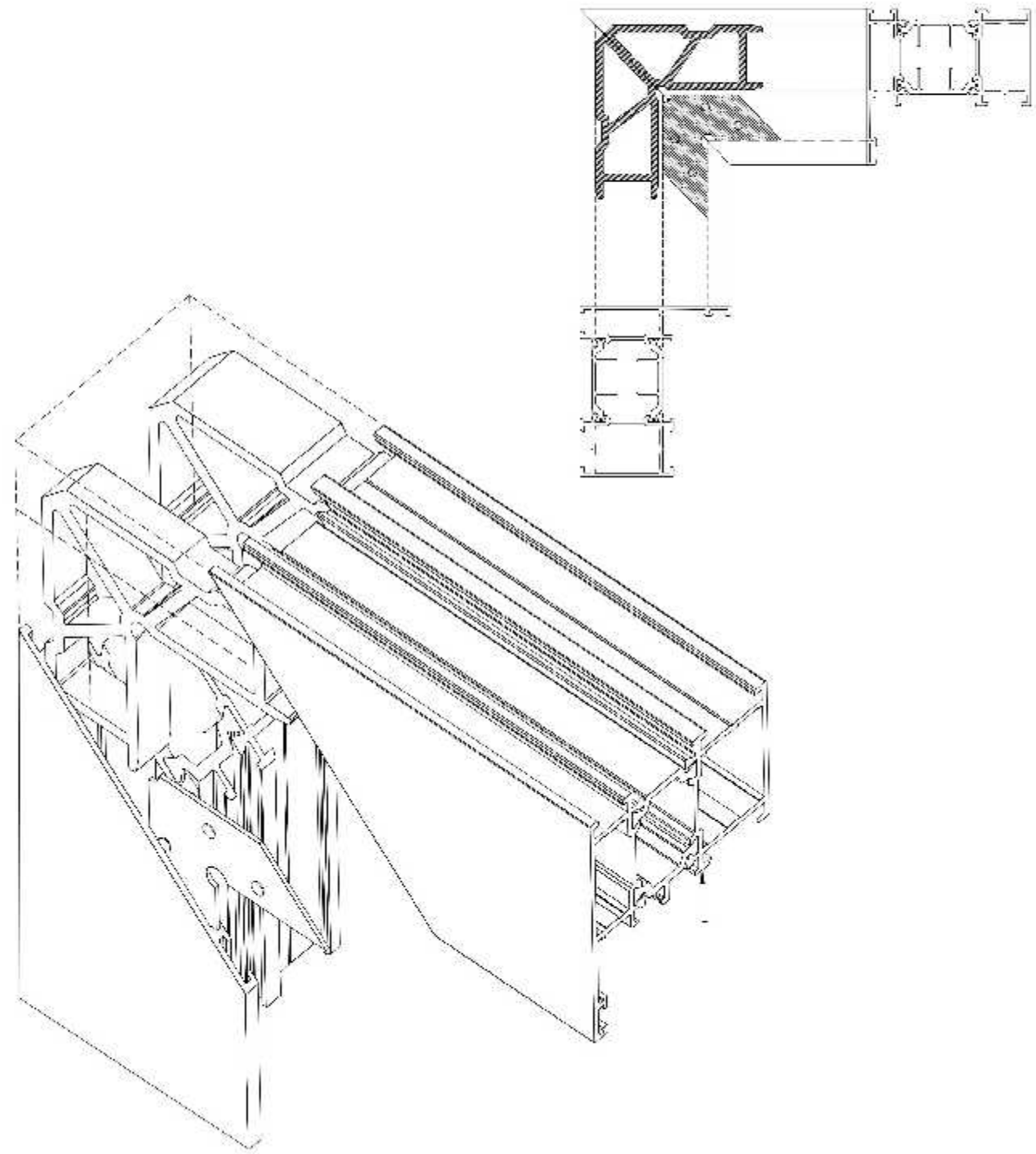

EW 55

Door & window Systems

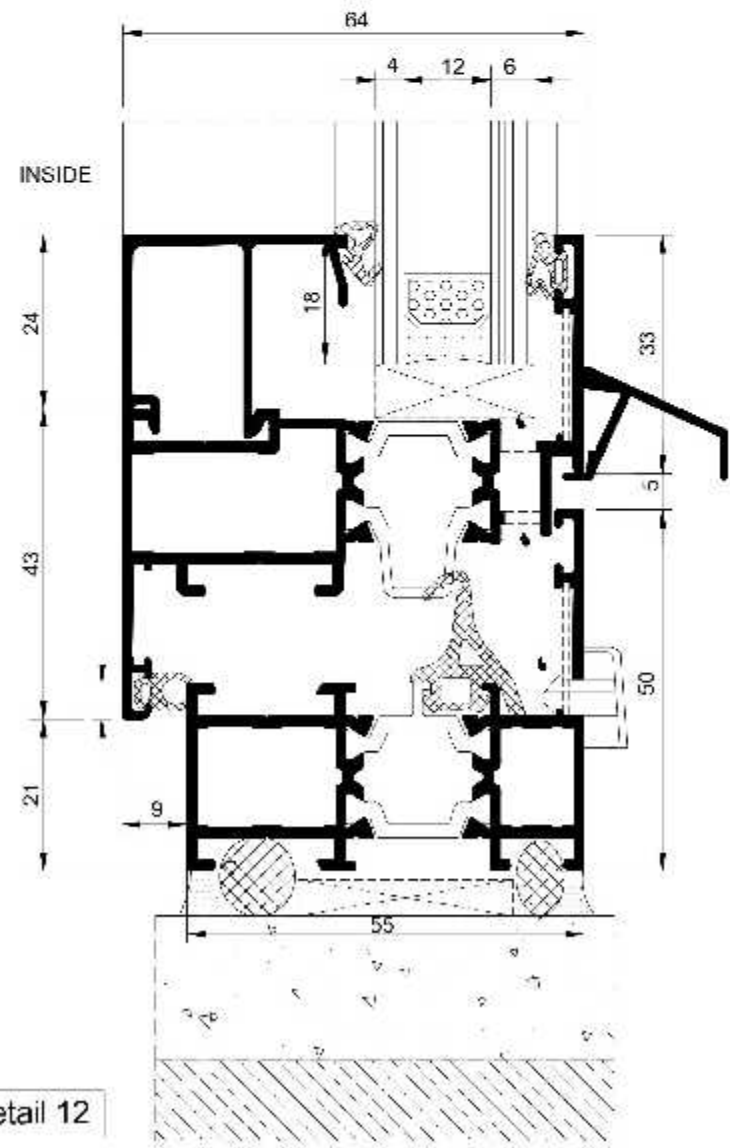
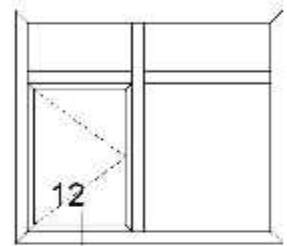

Detail 12



Door & window Systems

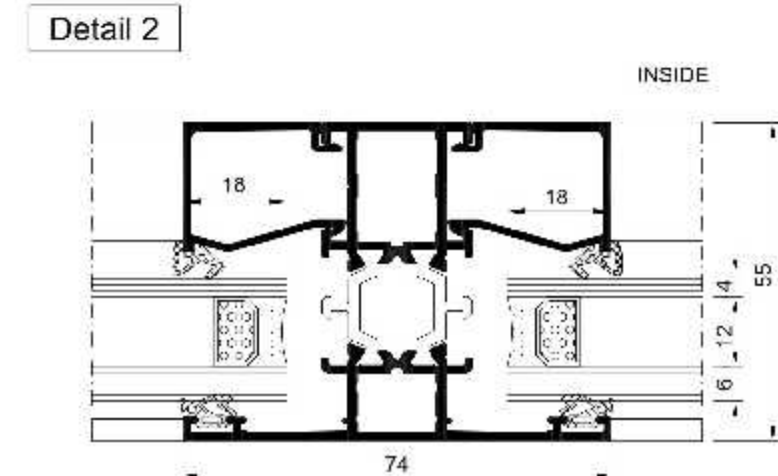
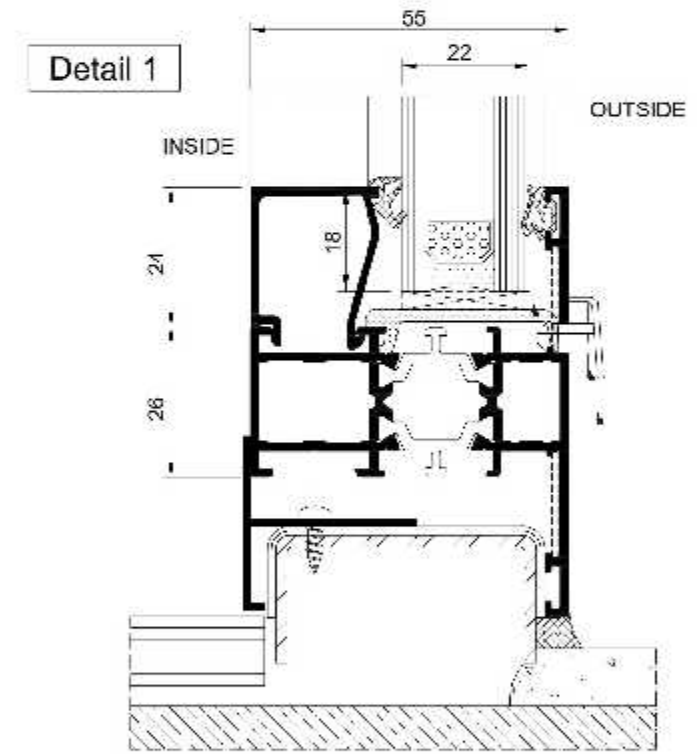
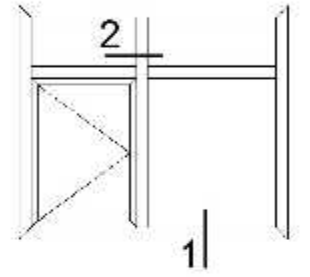

Detail 2

EW 55

Door & window Pivoted System



Door & window Pivoted System

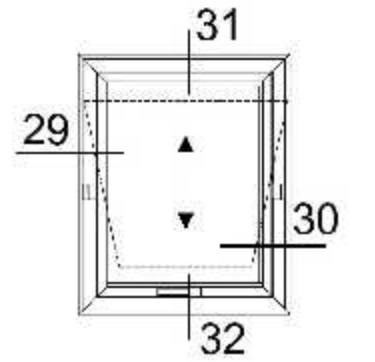
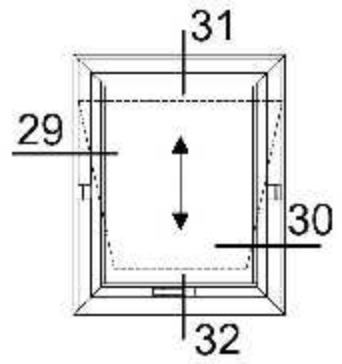

Detail 32

Detail 31

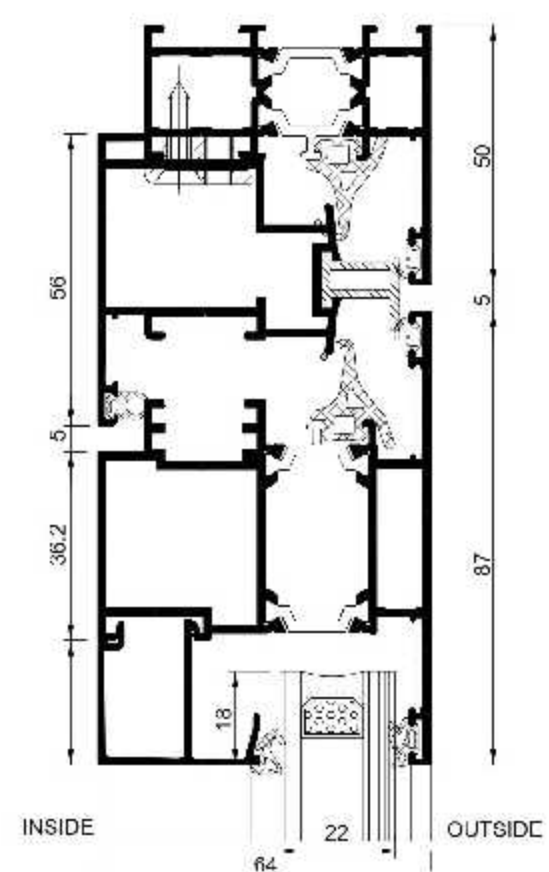
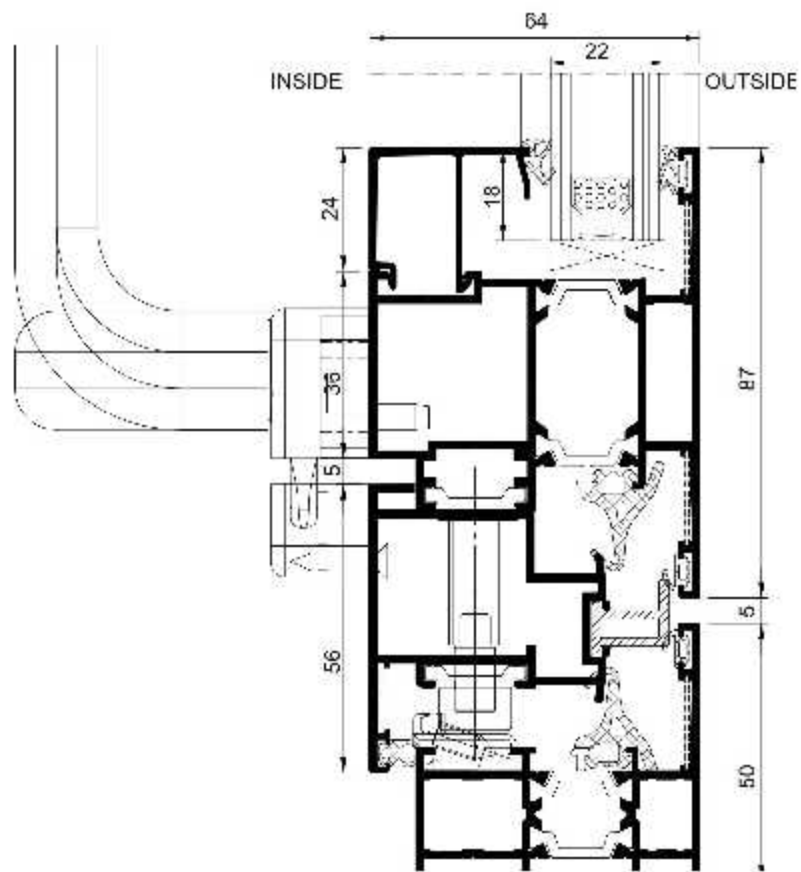

Detail 29

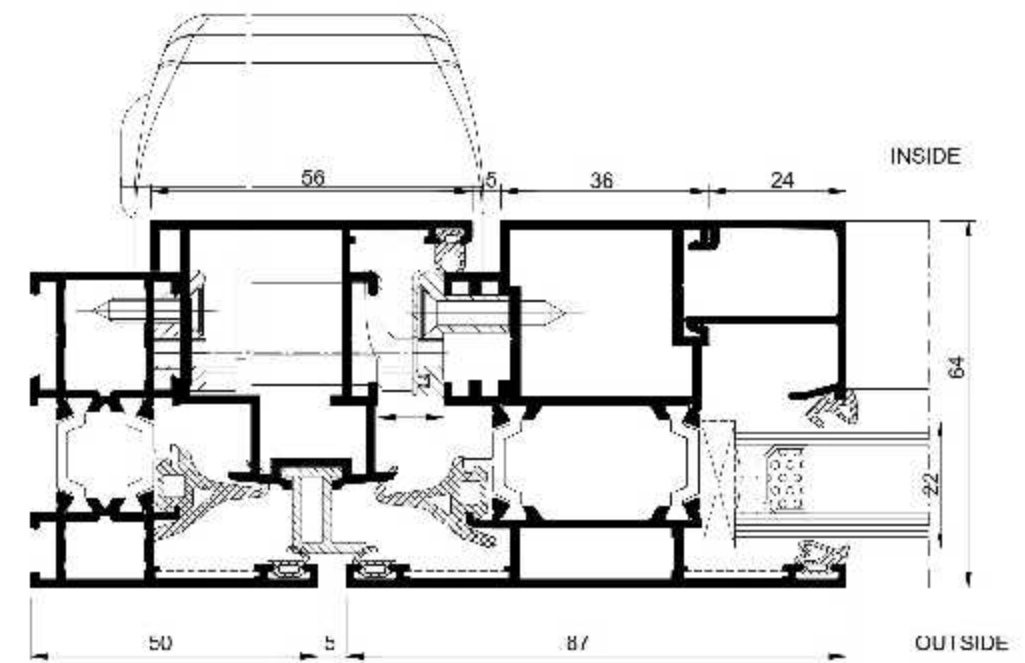

EW 55

Door & window Hidden System

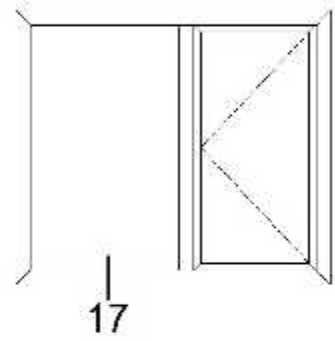

Door & window Hidden System

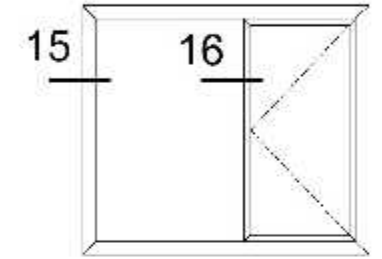

Detail 17

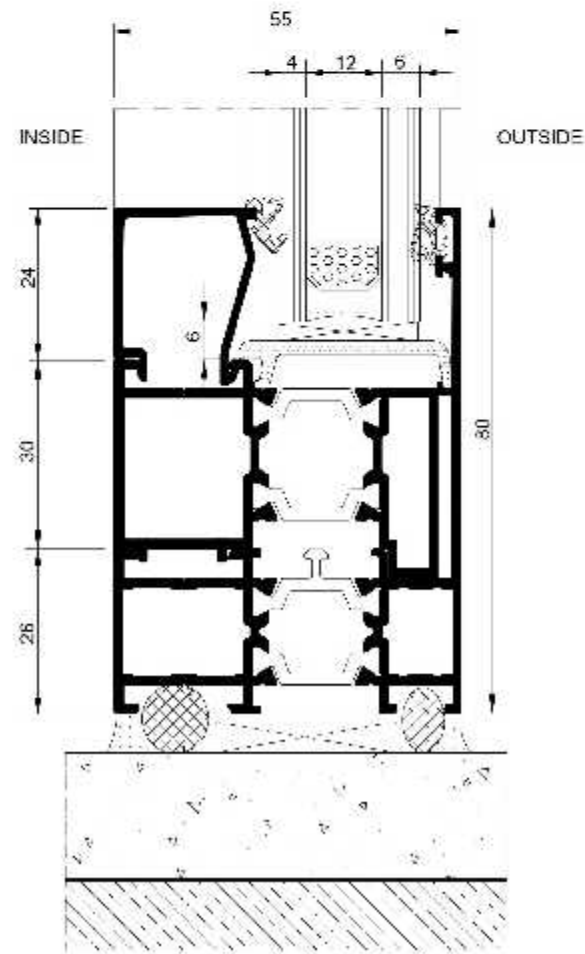

Detail 15

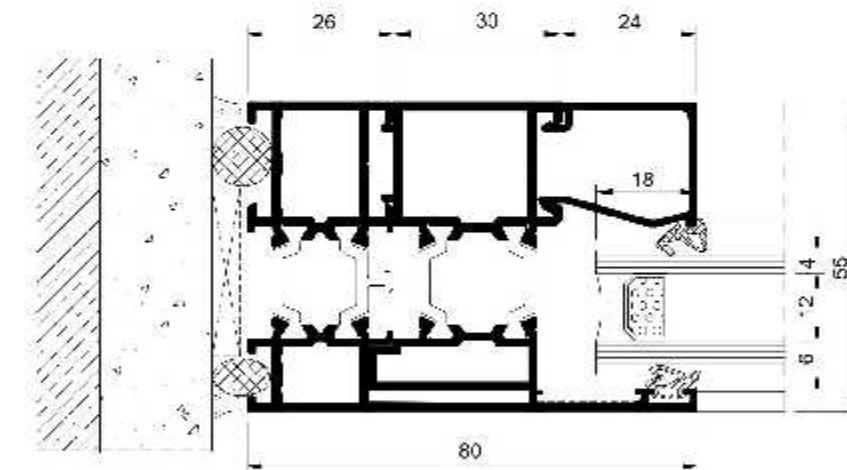

Detail 16

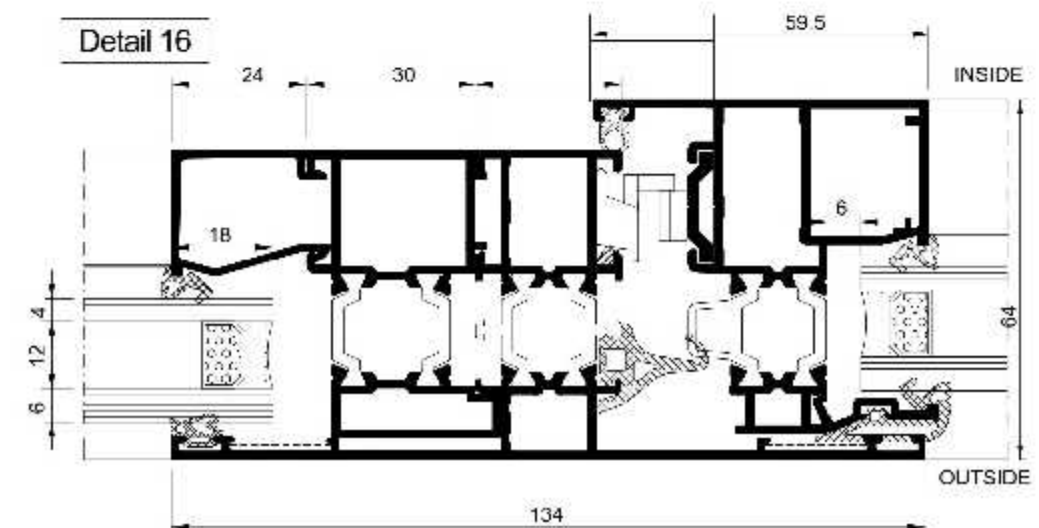

EW 55

Door & window Hidden System



Door & window Hidden System

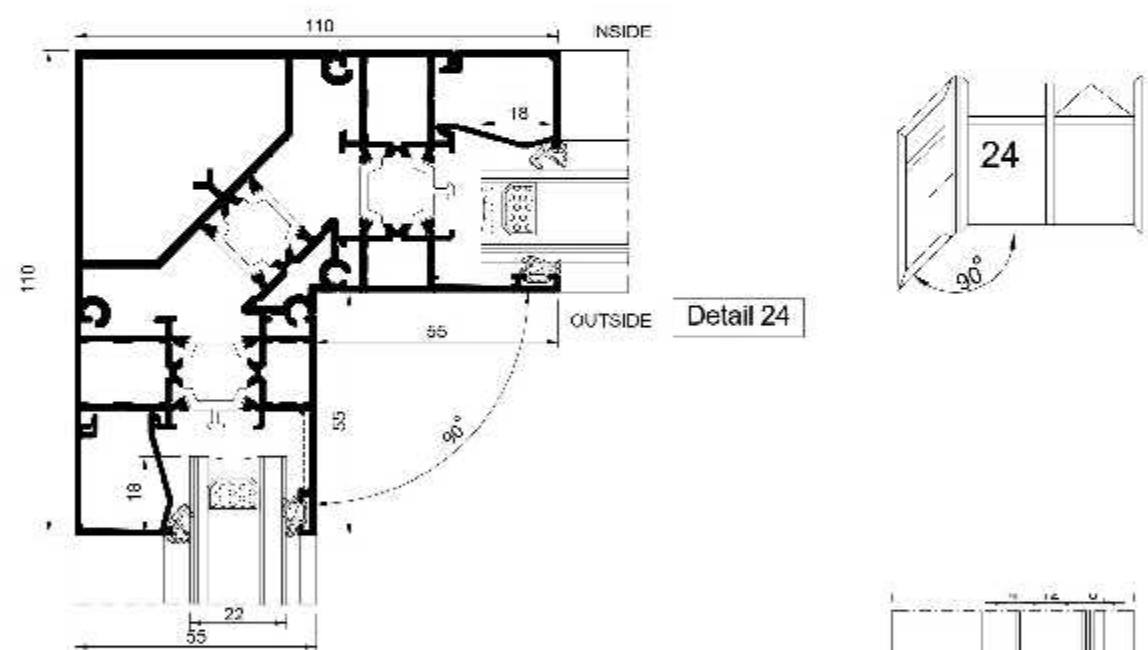
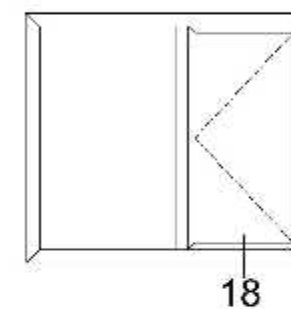

Detail 18

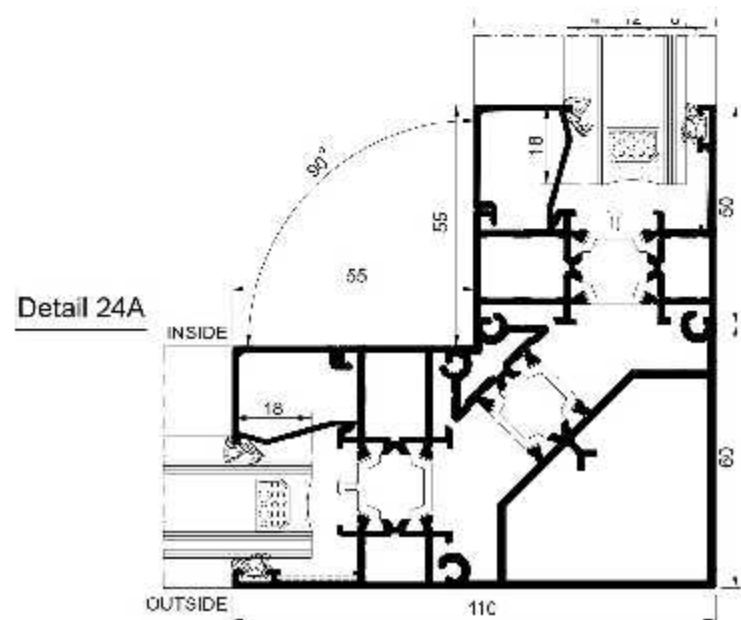
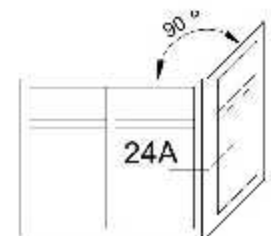
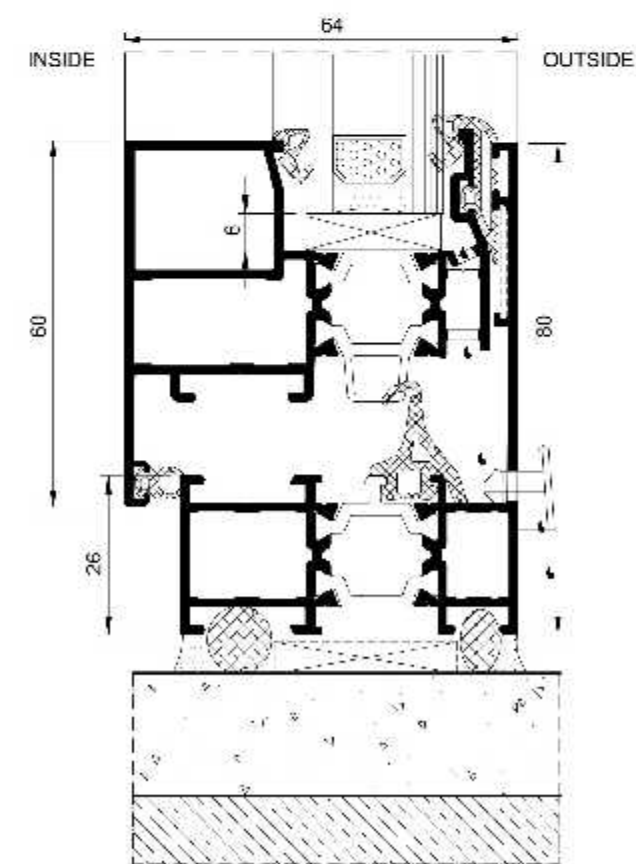

SSI 68

Door & window Sliding System



Door & window Sliding System

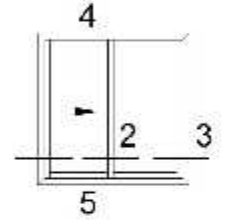
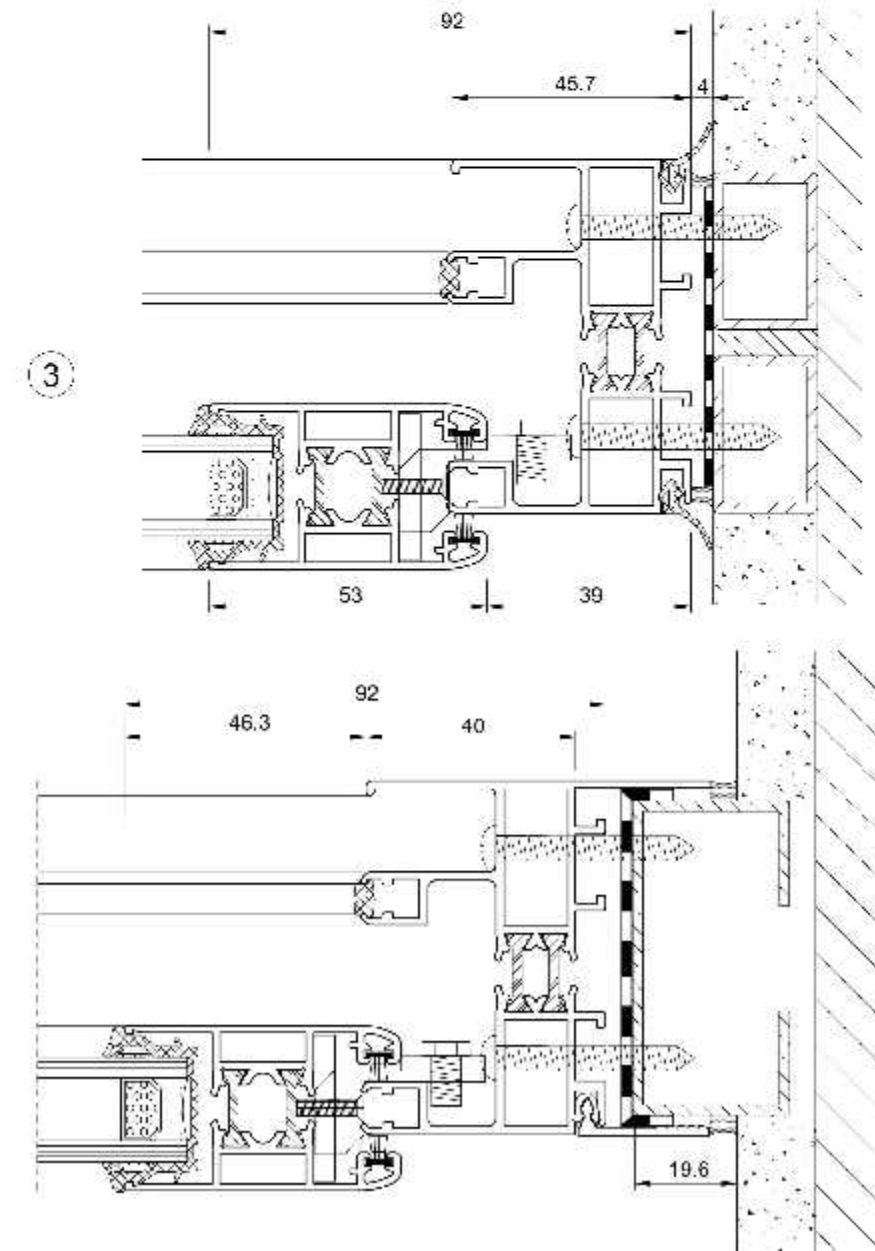
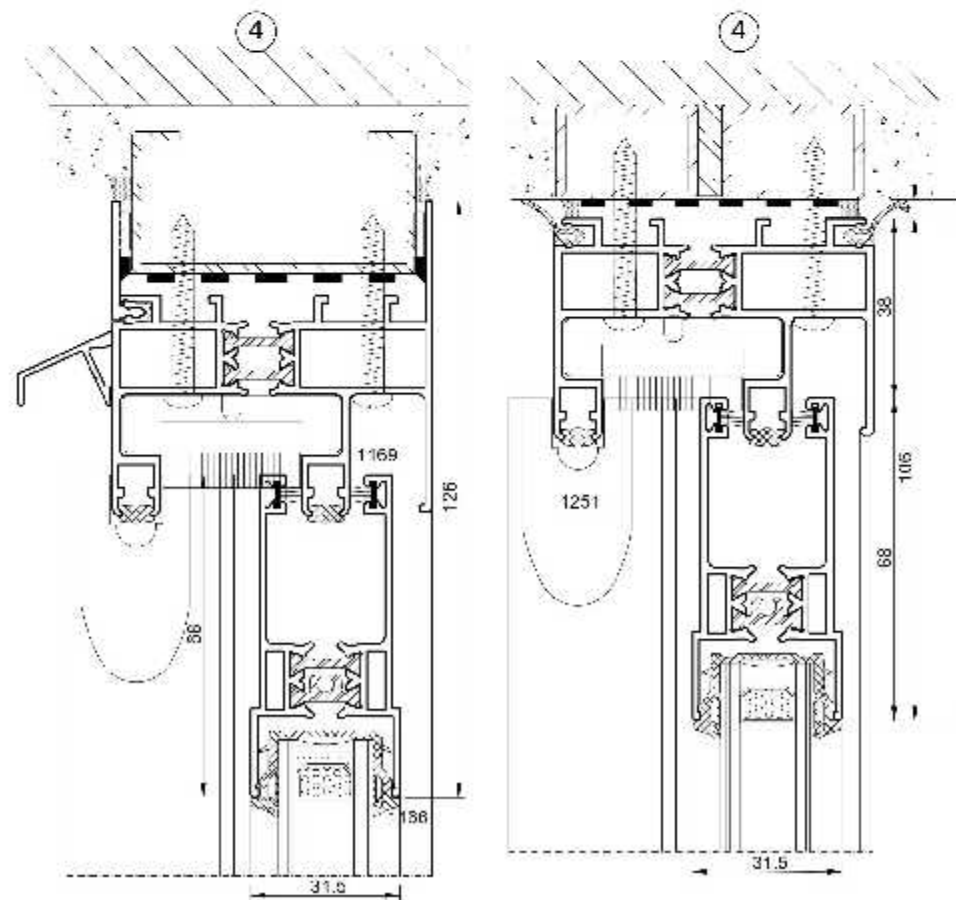
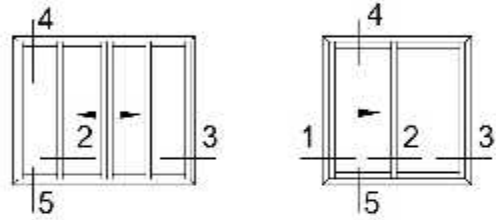

SSI 68

Door & window Sliding System



Door & window Sliding System

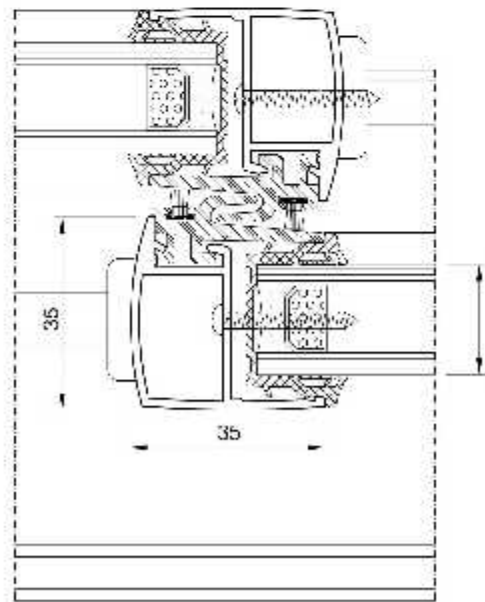
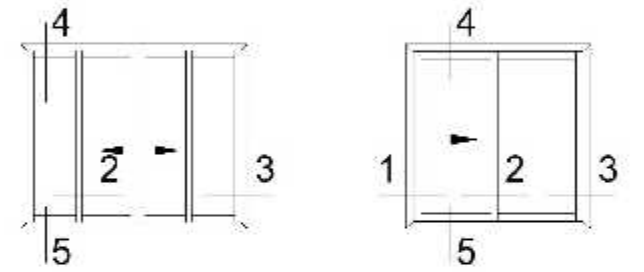
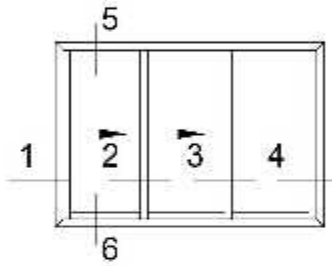

②

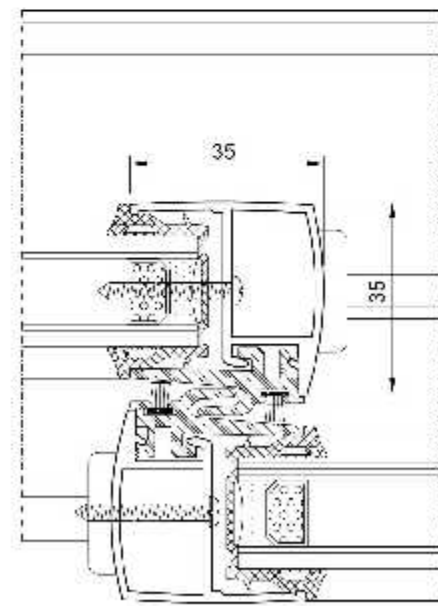

③

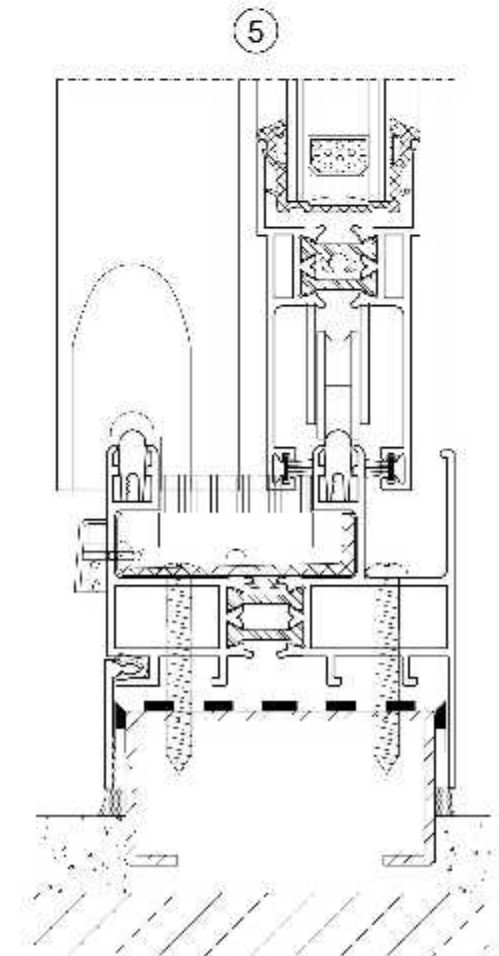
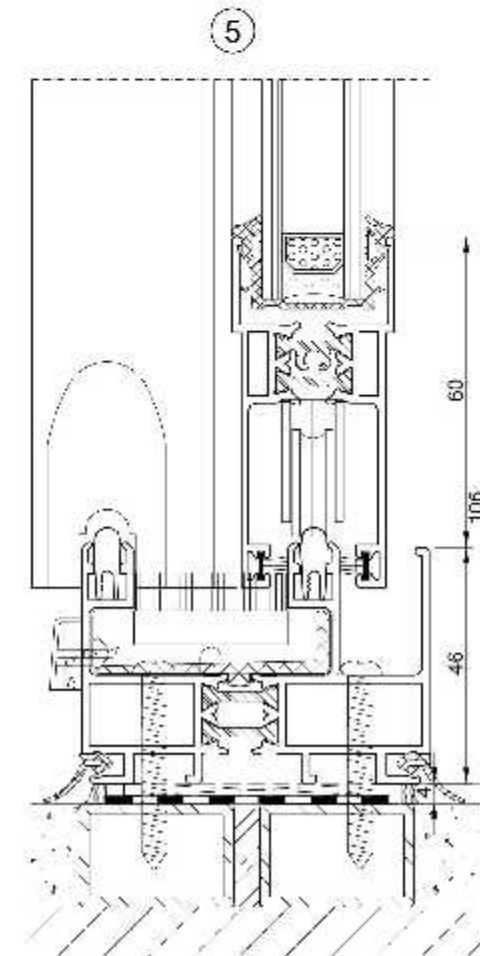

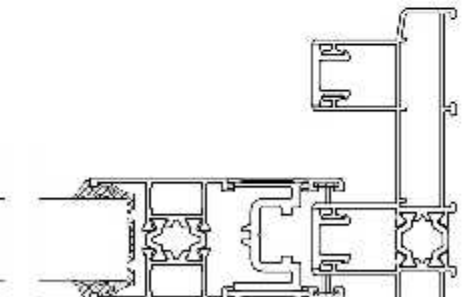
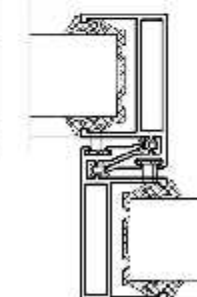
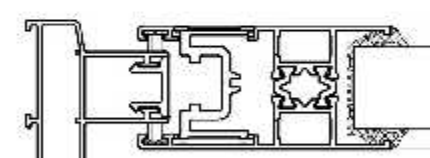
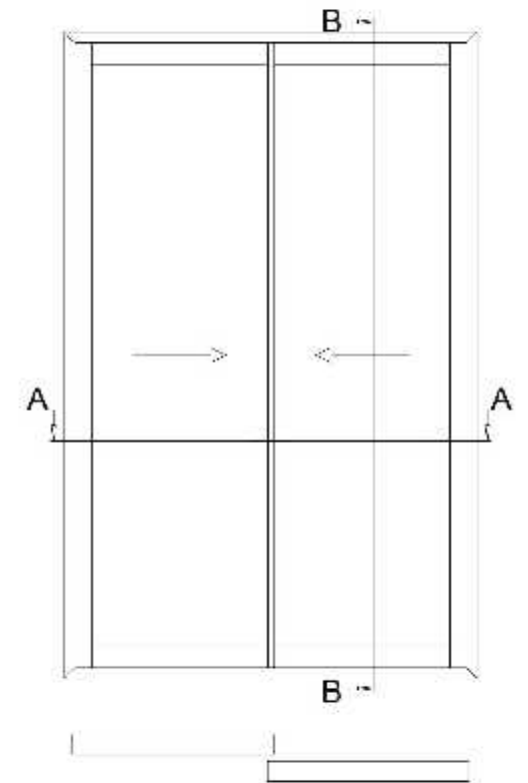
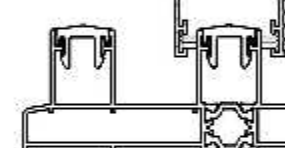
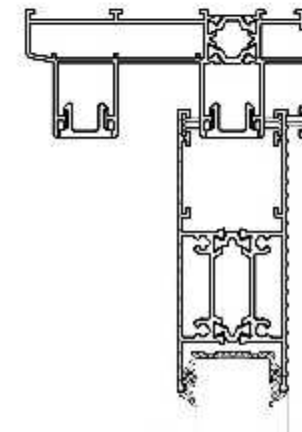

ST91

Door & window Sliding System

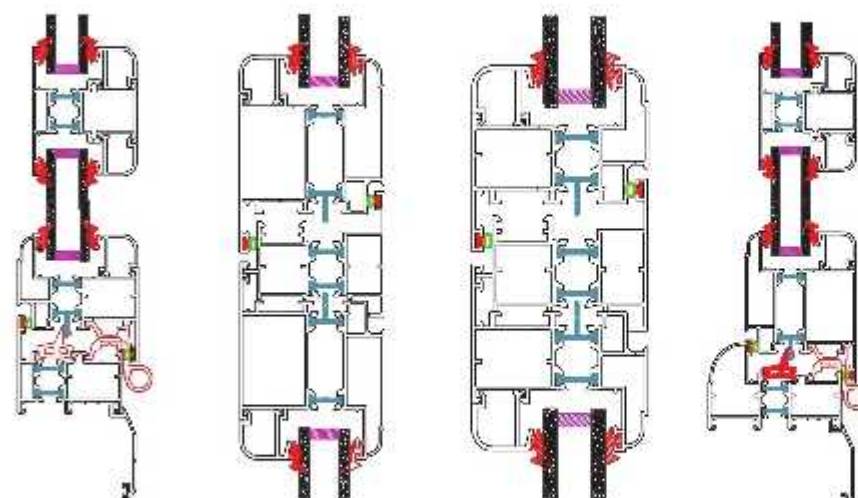
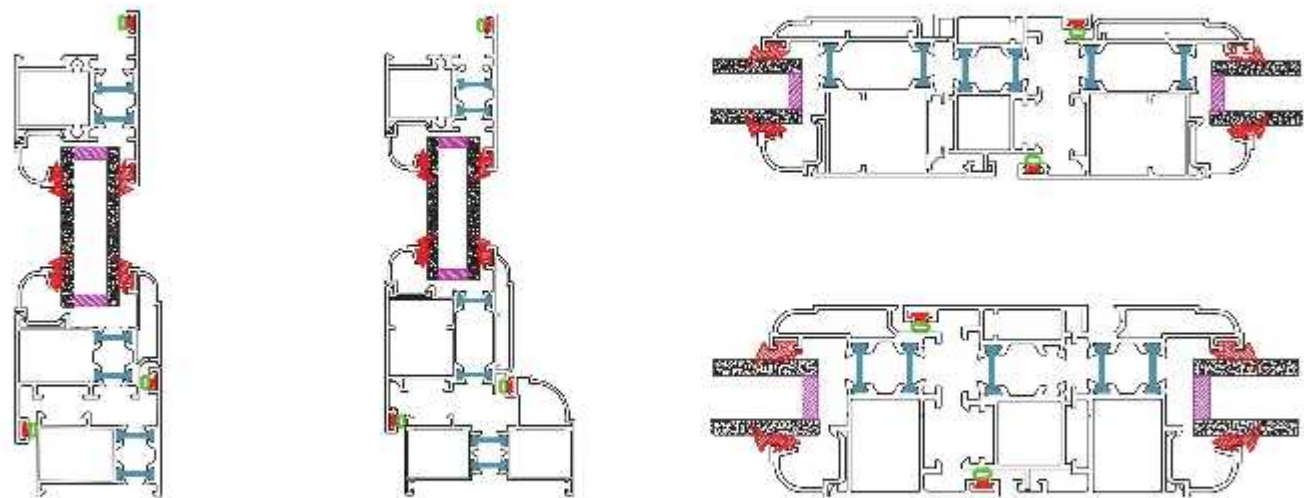



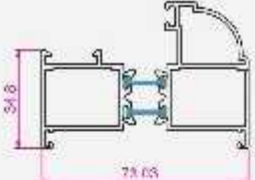
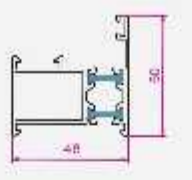
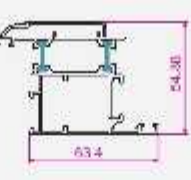
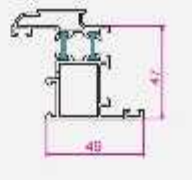
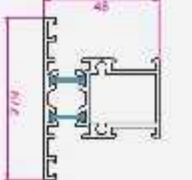
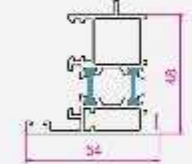
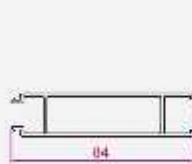
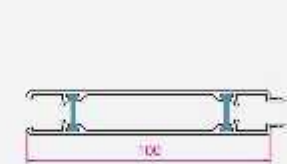





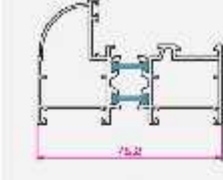
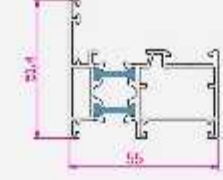
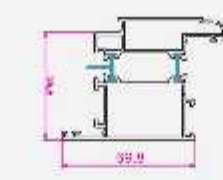
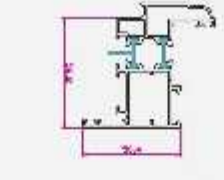
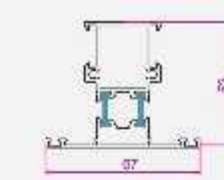
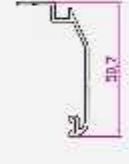

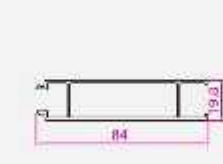
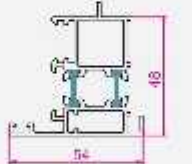
سیستم ترمال بریک لولایی سری B

				
فریم سنگین درب KP512	فریم سبک پنجره KP513	لنگه سنگین درب KP514	لنگه سبک پنجره KP515	سپری ترمال KP516
1300 (g/m)	950 (g/m)	1720 (g/m)	1250 (g/m)	1280 (g/m)
				
پروفیل وسط دو لنگه KP517	فاساد دو جداره KP510	فاساد ترمال بریک KP625	زهوار دو جداره KP518	
1120 (g/m)	800 (g/m)	530 (g/m)	230 (g/m)	

سیستم ترمال بریک لولایی سری A

				
فریم سنگین درب KP501	فریم سبک پنجره KP502	لنگه سنگین درب KP503	لنگه سبک پنجره KP504	سپری ترمال KP505
1310 (g/m)	1250 (g/m)	1600 (g/m)	1320 (g/m)	1200 (g/m)
				
روکوب KP506	زهوار دو جداره KP507	فاساد دو جداره KF510	پروفیل وسط دو لنگه KP517	تسمه KP508
320 (g/m)	610 (g/m)	600 (g/m)	1120 (g/m)	140 (g/m)
				
			تسمه KP509	تسمه KP509
			130 (g/m)	130 (g/m)

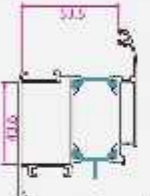
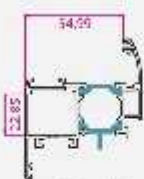
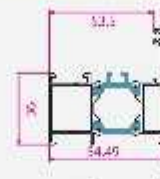
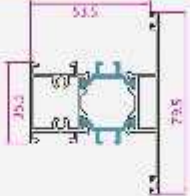
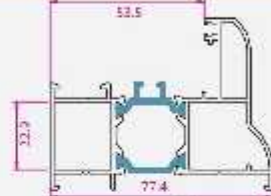
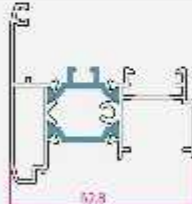
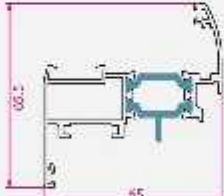
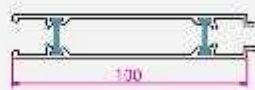
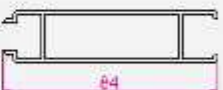
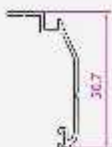
سیستم ترمال بریک لولایی سری C

				
لنگه سنگین درب KP628	لنگه سبک پنجره KP629	فریم سبک پنجره KP627	سپری KP630	فریم سنگین درب KP626
1550 (g/m)	1050 (g/m)	1100 (g/m)	1200 (g/m)	1450 (g/m)
				
پروفیل وسط دو لنگه KP631	لنگه میانی KP640	فاساد ترمال بریک KP625	فاساد دو جداره KP610	
1100 (g/m)	1230 (g/m)	530 (g/m)	800 (g/m)	
				
روکوب KP508	زهوار دو جداره KP632	نسمه KP508	نسمه KP509	
320 (g/m)	240 (g/m)	140 (g/m)	130 (g/m)	

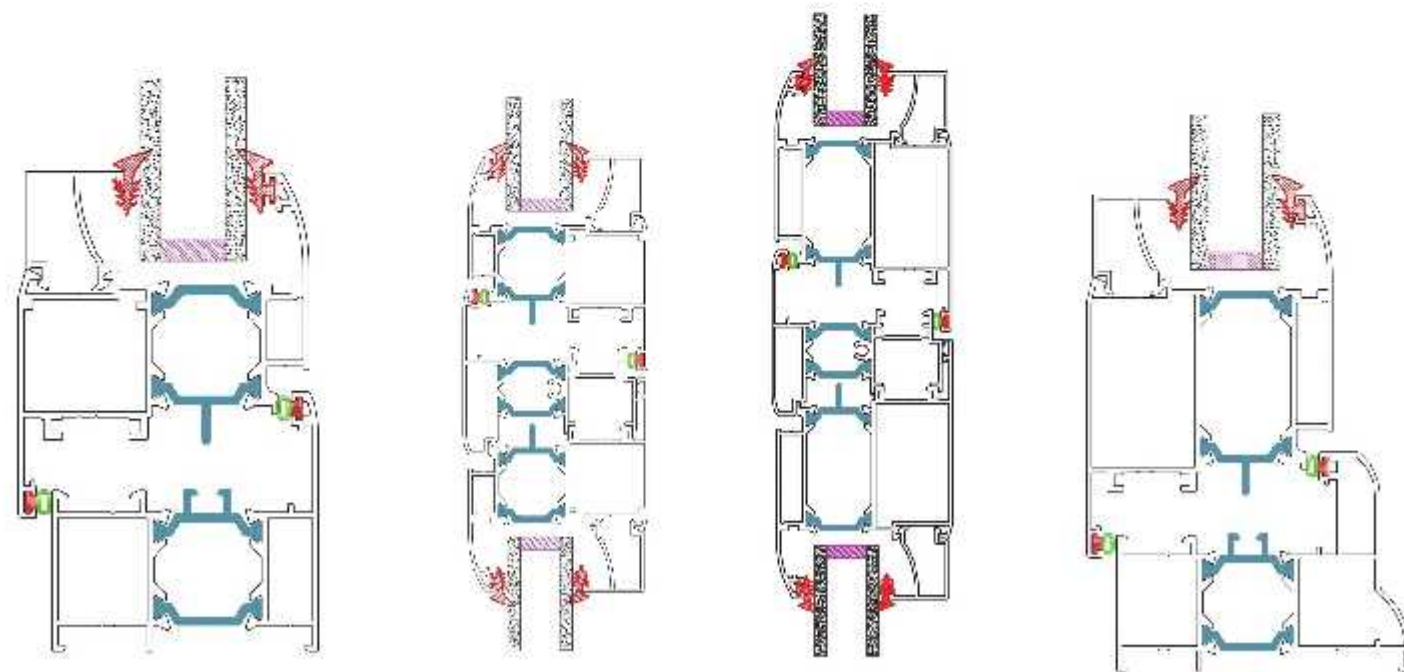

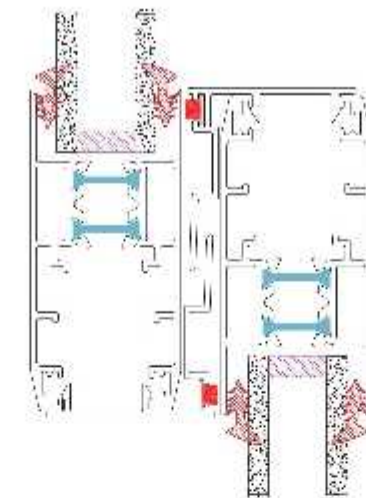
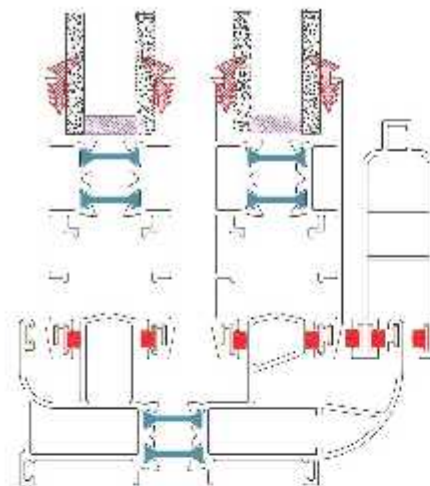
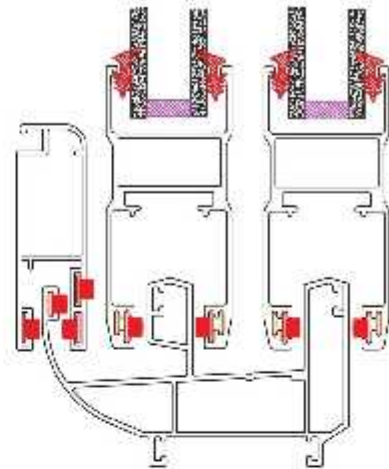
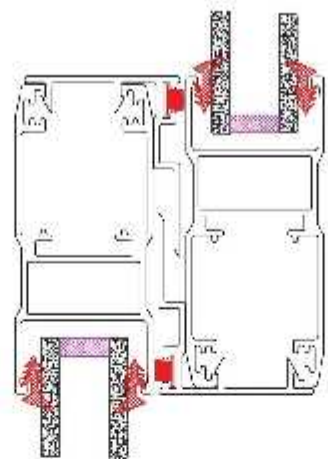

سیستم کشویی مینی

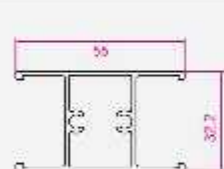

سپری کشویی
KP619

710
(g/m)

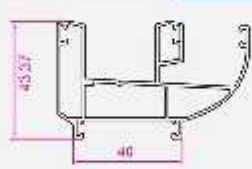

فریم کشویی
KP617

1100
(g/m)

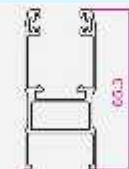

لنگه کشویی
KP618

820
(g/m)

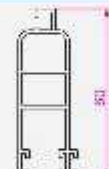

لنگه توری خور
KP524

670
(g/m)

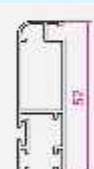

لنگه توری خور
KP623

480
(g/m)

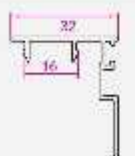

در پوش
KP620

130
(g/m)

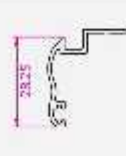

روکوب مینی
KP629

230
(g/m)

سیستم ترمال بریک کشویی

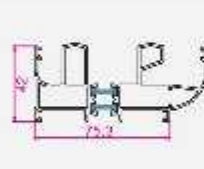

فریم کشویی ترمال
KP519

1600
(g/m)

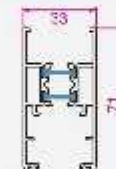

لنگه کشویی ترمال
KP520

1050
(g/m)



سپری کشویی
KP521

1100
(g/m)

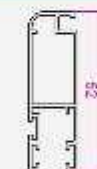

لنگه توری
KP523

480
(g/m)

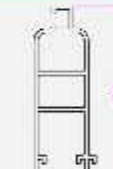

لنگه توری
KP524

670
(g/m)



روکوب
KP506



320
(g/m)



درپوش ترمال
KP522



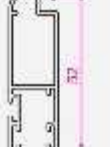
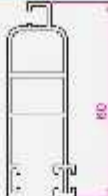
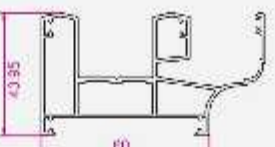
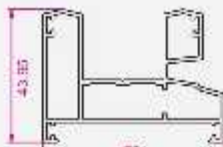
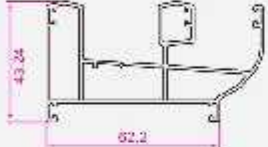
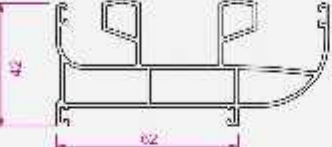
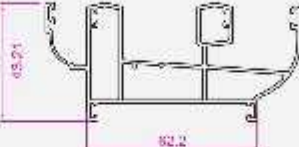
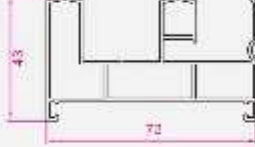
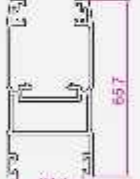
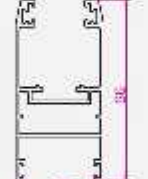
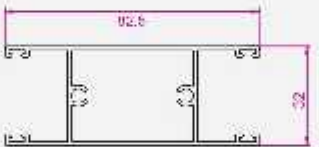
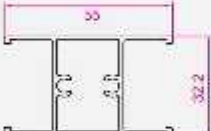
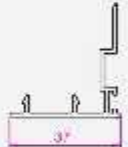

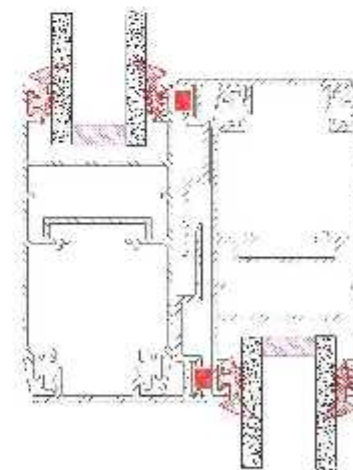
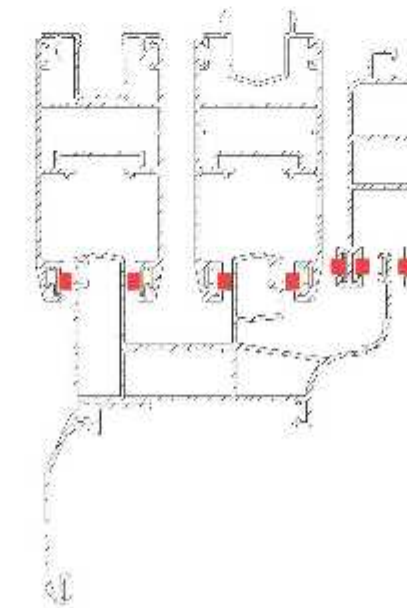
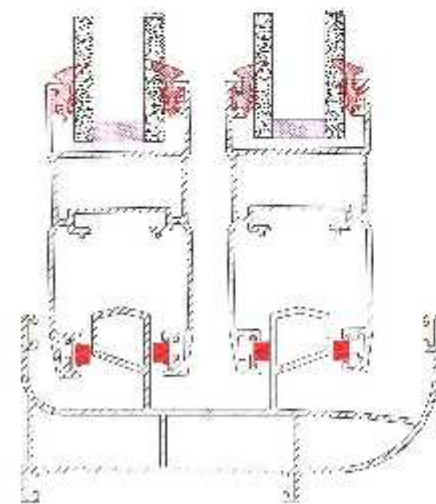

350
(g/m)

سیستم کشویی

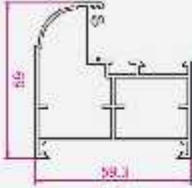
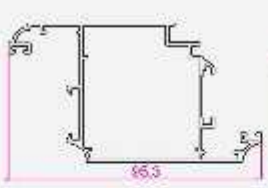
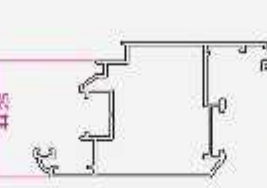
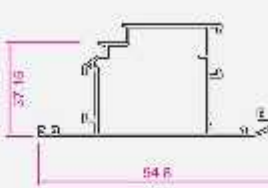
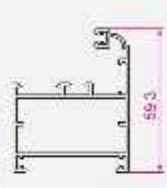
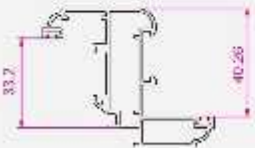
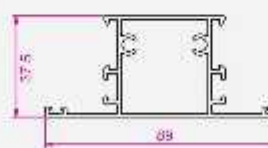
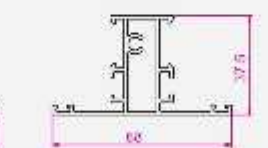
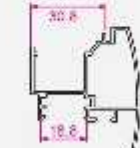
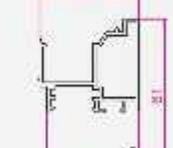
				
روکوب KP506	لنگه نوری KP523	لنگه نوری KP524	فریم کشویی KP333	فریم ساده کشویی KP538
320 (g/m)	480 (g/m)	670 (g/m)	1100 (g/m)	900 (g/m)
				
فریم کشویی KP534	فریم کشویی عرق گیر دار KP535	فریم کشویی سه شیار KP536	فریم کشویی KP537	
1150 (g/m)	1420 (g/m)	1280 (g/m)	1150 (g/m)	
				
لنگه طرح دار کشویی KP539	لنگه صاف کشویی KP540	سپری کشویی بزرگ KP541	سپری کشویی کوچک KP619	دربوش KP542
880 (g/m)	880 (g/m)	990 (g/m)	770 (g/m)	340 (g/m)
				
زهوار چهار لنگه کشویی KP544	زهوار تک جداره کشویی KP543			
170 (g/m)	270 (g/m)			

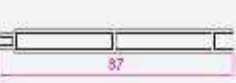

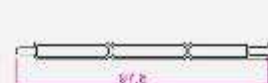
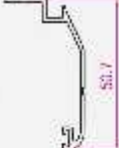
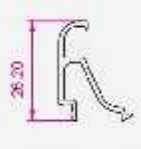
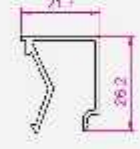
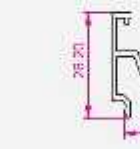
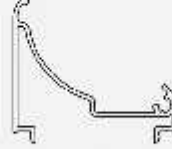
سیستم لولایی سری A

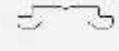
				
فریم درب لولایی KP590	لنگه درب KP591	لنگه درب KP592	لنگه درب بیرون باز شو KP593	فریم سبک پنجره KP594
1000 (gr/m)	1090 (gr/m)	1200 (gr/m)	900 (gr/m)	840 (gr/m)
				
لنگه پنجره KP595	سبزی درب KP596	سبزی سبک پنجره KP597	پروفیل وسط دو لنگه KP598	پروفیل وسط دو لنگه KP599
890 (gr/m)	950 (gr/m)	750 (gr/m)	720 (gr/m)	740 (gr/m)
				
فاساد تک خط تک جداره KP563	فاساد تک جداره ساده KP564	فاساد دو جداره KP510	فاساد دو خط تک جداره KP511	روکوب KP506
740 (gr/m)	580 (gr/m)	800 (gr/m)	720 (gr/m)	320 (gr/m)
				
زهوار دو جداره گرده ماهی KP561	زهوار تک جداره KP562	زهوار دو جداره KP560	ناخن KP665	لوله KP666
235 (gr/m)	280 (gr/m)	230 (gr/m)	450 (gr/m)	600 (gr/m)
				
				نیمه KP508
				
				نیمه KP509
				140 (gr/m)
				130 (gr/m)

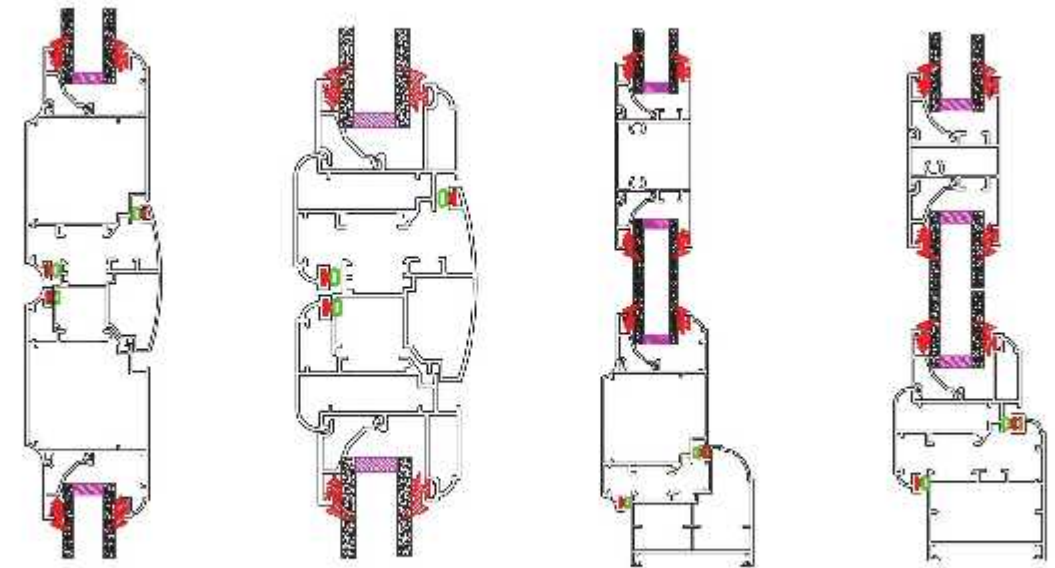

سیستم لولایی سری B

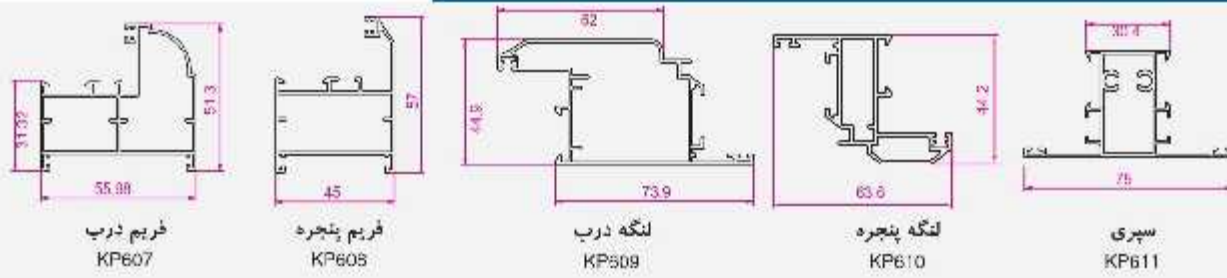

فریم درب KP607 فریم پنجره KP608 لنگه درب KP609 لنگه پنجره KP610 سپری KP611

770 (g/m) 700 (g/m) 980 (g/m) 880 (g/m) 765 (g/m)

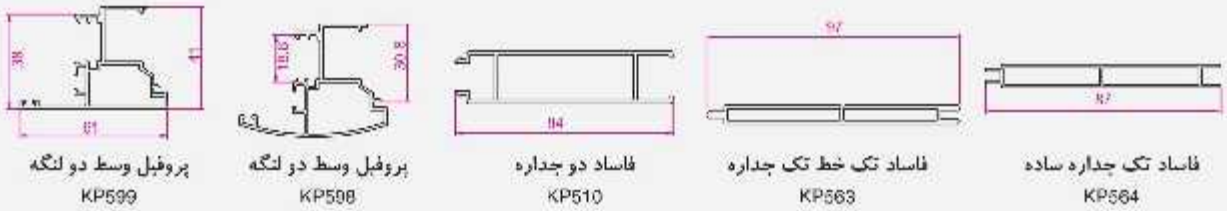

پروفیل وسط دو لنگه KP599 پروفیل وسط دو لنگه KP598 فاساد دو جداره KP510 فاساد تک خط تک جداره KP563 فاساد تک جداره ساده KP564

740 (g/m) 720 (g/m) 800 (g/m) 740 (g/m) 580 (g/m)

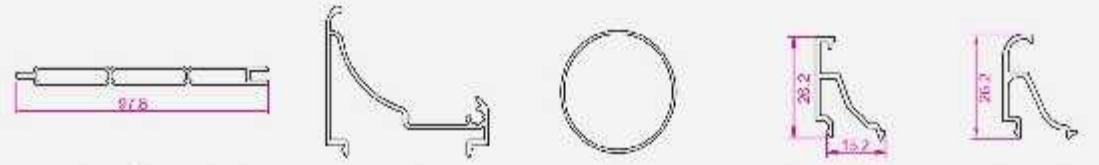

فاساد دو خط تک جداره KP511 ناخن KP565 لوله KP566 زهوار دو جداره KP560 زهوار دو جداره KP561

720 (g/m) 450 (g/m) 600 (g/m) 230 (g/m) 235 (g/m)

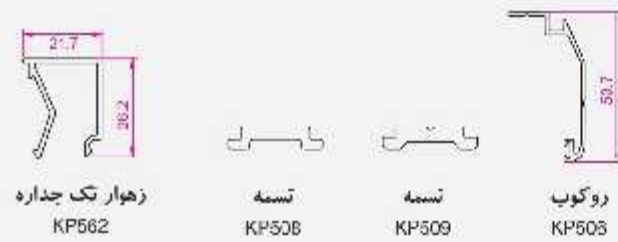

زهوار تک جداره KP562 تسمه KP508 تسمه KP509 روکوب KP503

280 (g/m) 140 (g/m) 130 (g/m) 320 (g/m)

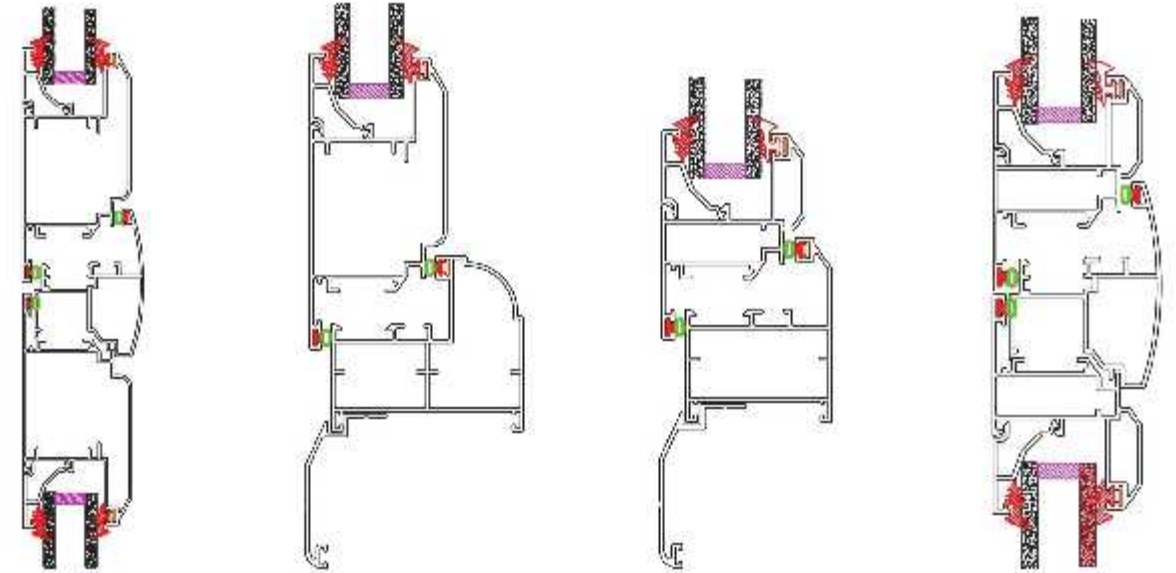

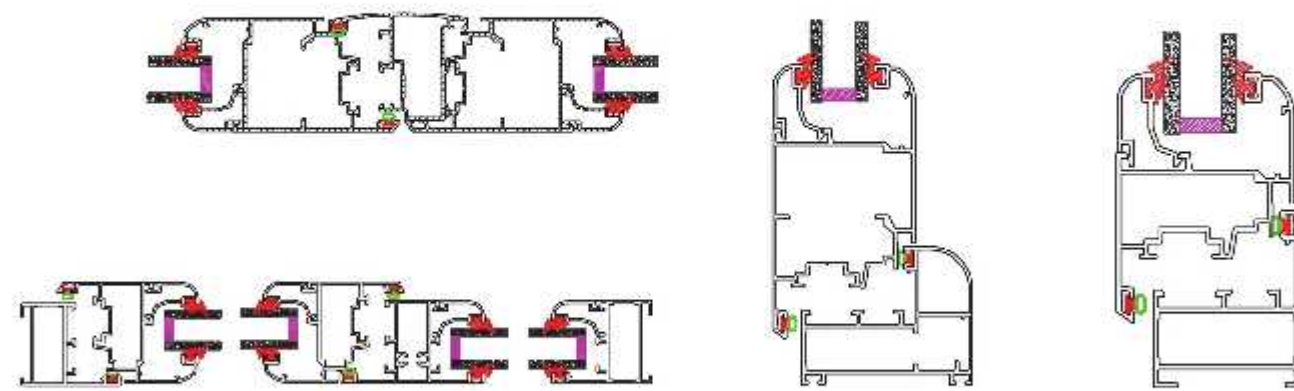
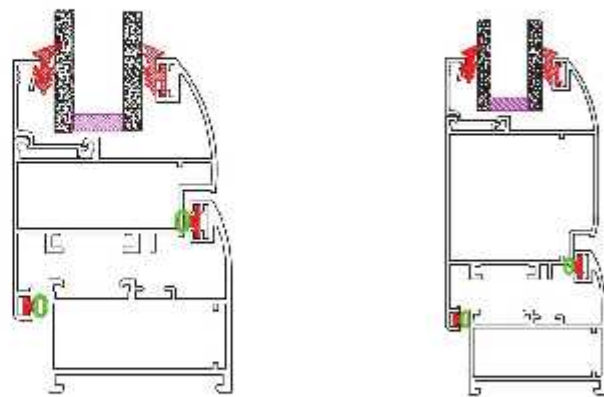

سیستم لولایی سری D

لنگه درب KP513	سپری KP615	زهوار دو چداره KP610	فریم KP512	لنگه پنجره KP614
1120 (g/m)	875 (g/m)	170 (g/m)	780 (g/m)	900 (g/m)
فاساد دو چداره KP510	روکوب KP506	تسمه KP508	تسمه KP509	
800 (g/m)	320 (g/m)	140 (g/m)	130 (g/m)	

سیستم لولایی سری C

پروفیل وسط دو لنگه KP604	فریم سنگین درب KP598	فریم سبک پنجره KP599	لنگه سنگین درب KP600	لنگه سبک پنجره KP601
780 (g/m)	950 (g/m)	880 (g/m)	1100 (g/m)	900 (g/m)
سپری سبک پنجره KP602	سپری درب KP603	فاساد تک چداره ساده KP564	زهوار دو چداره KP605	زهوار تک چداره KP606
880 (g/m)	1750 (g/m)	640 (g/m)	250 (g/m)	290 (g/m)

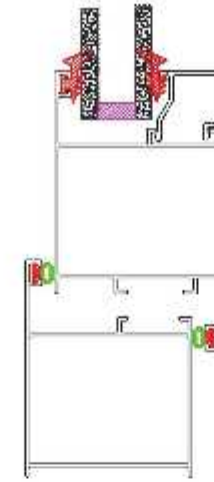
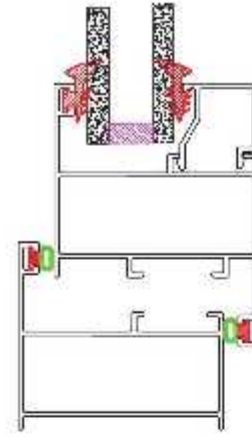
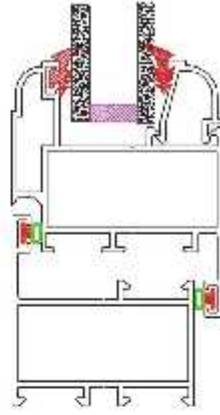
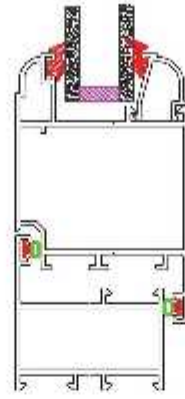
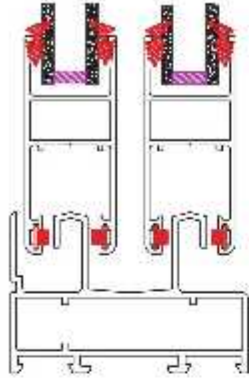

سیستم کشویی و لولایی سری A

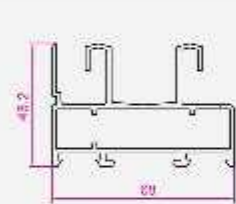

فریم کشویی
KP582

1390
(g/m)

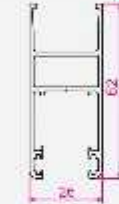

لنگه کشویی
KP583

760
(g/m)

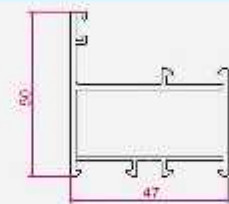

فریم لولایی
KP584

800
(g/m)

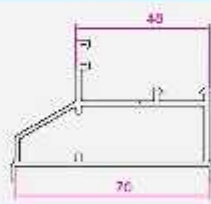

فریم ثابت لولایی
KP587

1020
(g/m)

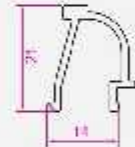

زهوار دو جداره
KP589

230
(g/m)

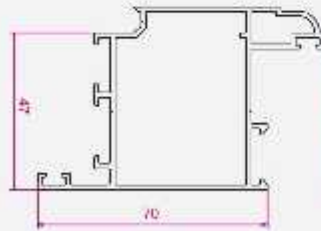

لنگه درب لولایی
KP585

1320
(g/m)

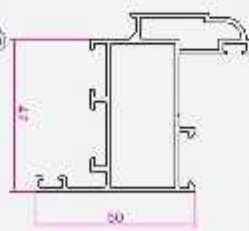

لنگه پنجره لولایی
KP586

1110
(g/m)



سپری سنگین
KP588

2050
(g/m)

سیستم لولایی سبک

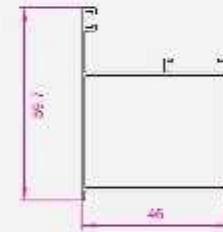

فریم سنگین درب
KP525

570
(g/m)

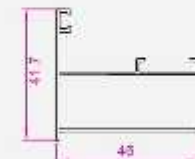

فریم پنجره
KP526

480
(g/m)

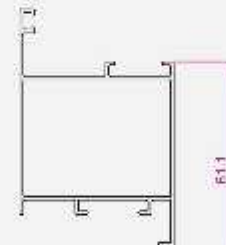

لنگه سنگین درب
KP527

690
(g/m)

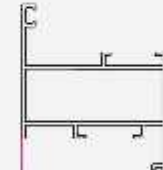

لنگه سبک پنجره
KP528

600
(g/m)

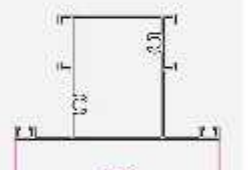

سپری سنگین
KP529

740
(g/m)

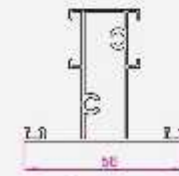

سپری سبک
KP530

850
(g/m)

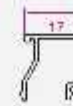

زهوار دو جداره
KP531

190
(g/m)

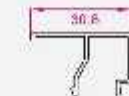

زهوار تک جداره
KP532

230
(g/m)

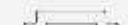

نسمه
KP508



140
(g/m)



نسمه
KP509

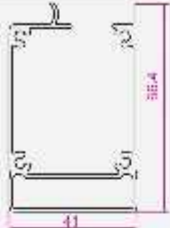
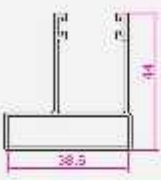
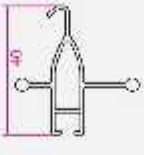
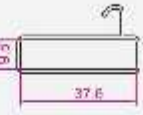

130
(g/m)

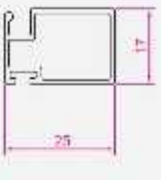
سیستم توری رولینگ سری A



					
پوسته رولینگ KP550	ریل رولینگ KP551	کلیس رولینگ KP552	پایه کلیس رولینگ KP553	لوله رولینگ KP554	توری ثابت KP555
980 (g/m)	600 (g/m)	400 (g/m)	370 (g/m)	270 (g/m)	260 (g/m)

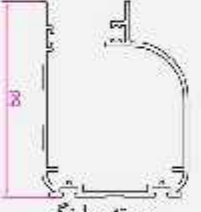
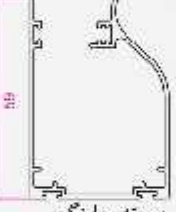
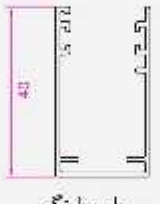

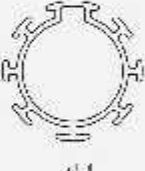

سیستم توری رولینگ سری B

					
پوسته رولینگ KP556	پوسته رولینگ KP557	ریل رولینگ KP558	قوطی ریل KP559	کلیس KP560	لوله KP561
750 (g/m)	710 (g/m)	390 (g/m)	400 (g/m)	500 (g/m)	320 (g/m)

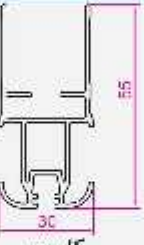
سیستم توری پلیسه

		
پوسته پلیسه KP573	ریل پلیسه KP574	کلیس KP575
440 (g/m)	400 (g/m)	680 (g/m)

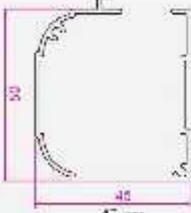
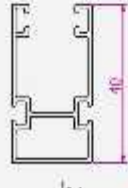
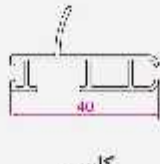
سیستم توری رولینگ سری C

				
پوسته KP562	ریل KP563	کلیس KP564	پایه کلیس KP565	لوله KP566
600 (g/m)	400 (g/m)	380 (g/m)	285 (g/m)	290 (g/m)

سیستم توری پلیسه مگنتی

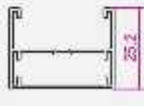
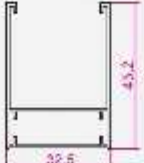
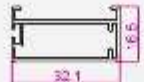
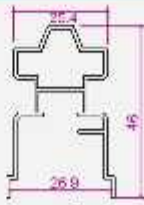
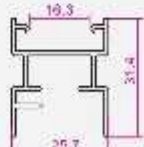
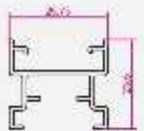
					
عرض پایین KP568	عرض بالا KP567	ارتفاع KP569	متحرک KP570	چفت کن راست KP571	چفت کن چپ KP572
280 (g/m)	485 (g/m)	285 (g/m)	370 (g/m)	340 (g/m)	290 (g/m)

سیستم درب کرکره ای



490 (g/m) 470 (g/m) 470 (g/m) 570 (g/m) 850 (g/m)



590 (g/m) 480 (g/m) 500 (g/m) 440 (g/m) 400 (g/m)

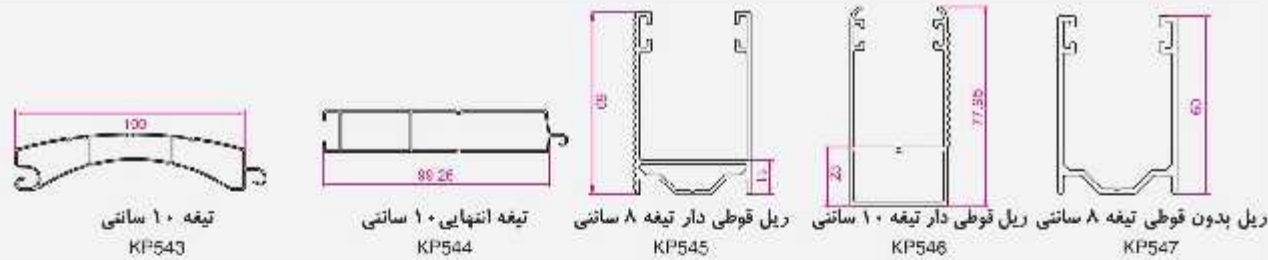

630 (g/m) 600 (g/m) 850 (g/m) 1060 (g/m) 890 (g/m)

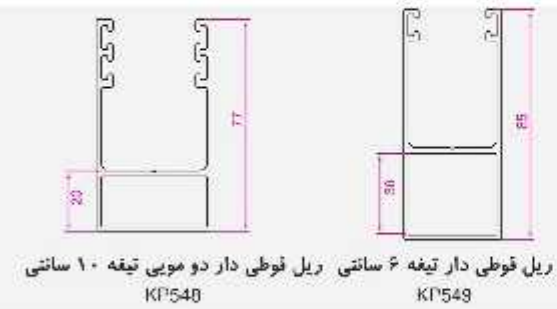

1400 (g/m) 1260 (g/m)

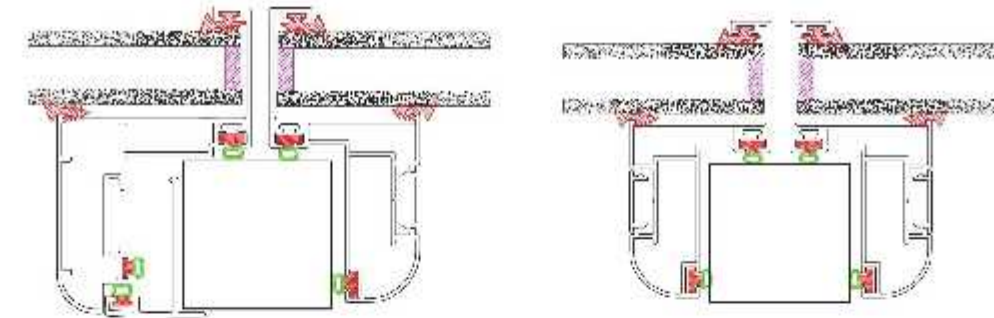

سیستم فریم لس دو جداره

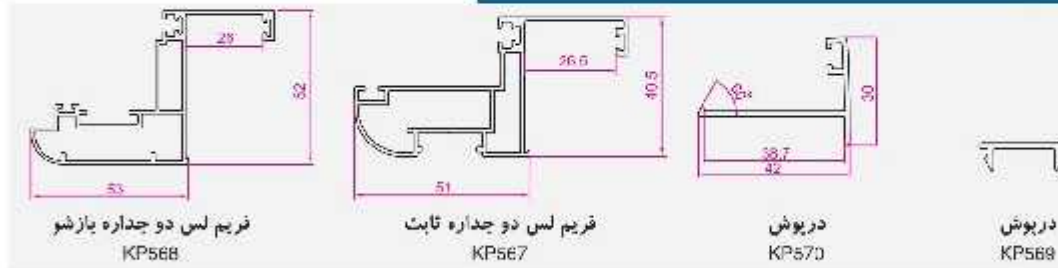

980 (g/m) 840 (g/m) 360 (g/m) 90 (g/m)



